

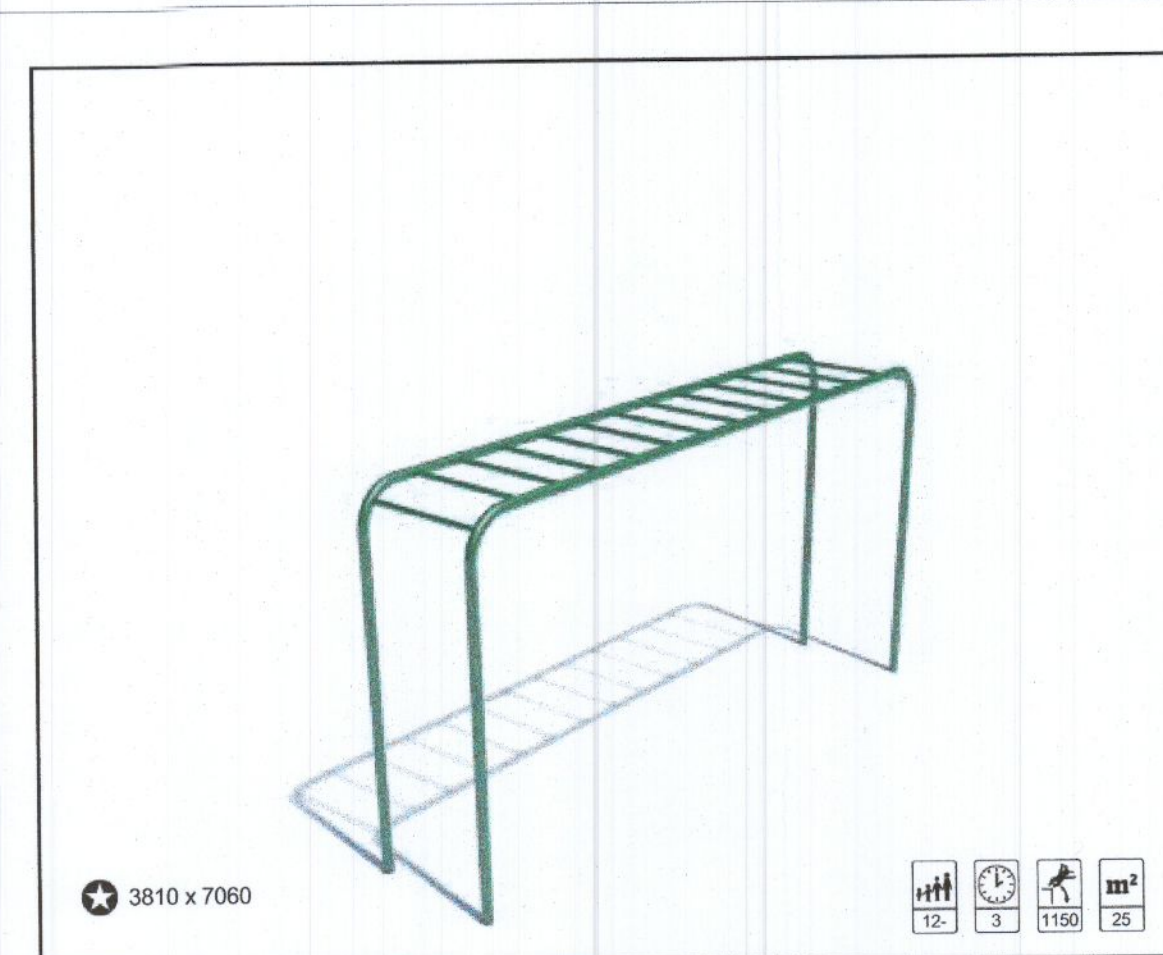

- 1 Outdoor Gym equipment, Horizontal Ladder
- 2 Outdoor Gym equipment, Lateral pull and chest press
- 3 Play unit, Sungam
- 4 Play equipment, spring rocker Klump
- 5 Informal Kickabout space
- 6 Play area information board, with details of the age profile per play item and emergency contact details



Inshape Horizontal Ladder

8036730 CC Green - Cast In Place

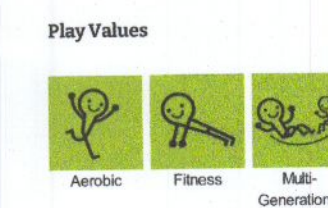

HAGS

1 Outdoor Gym equipment, Horizontal Ladder

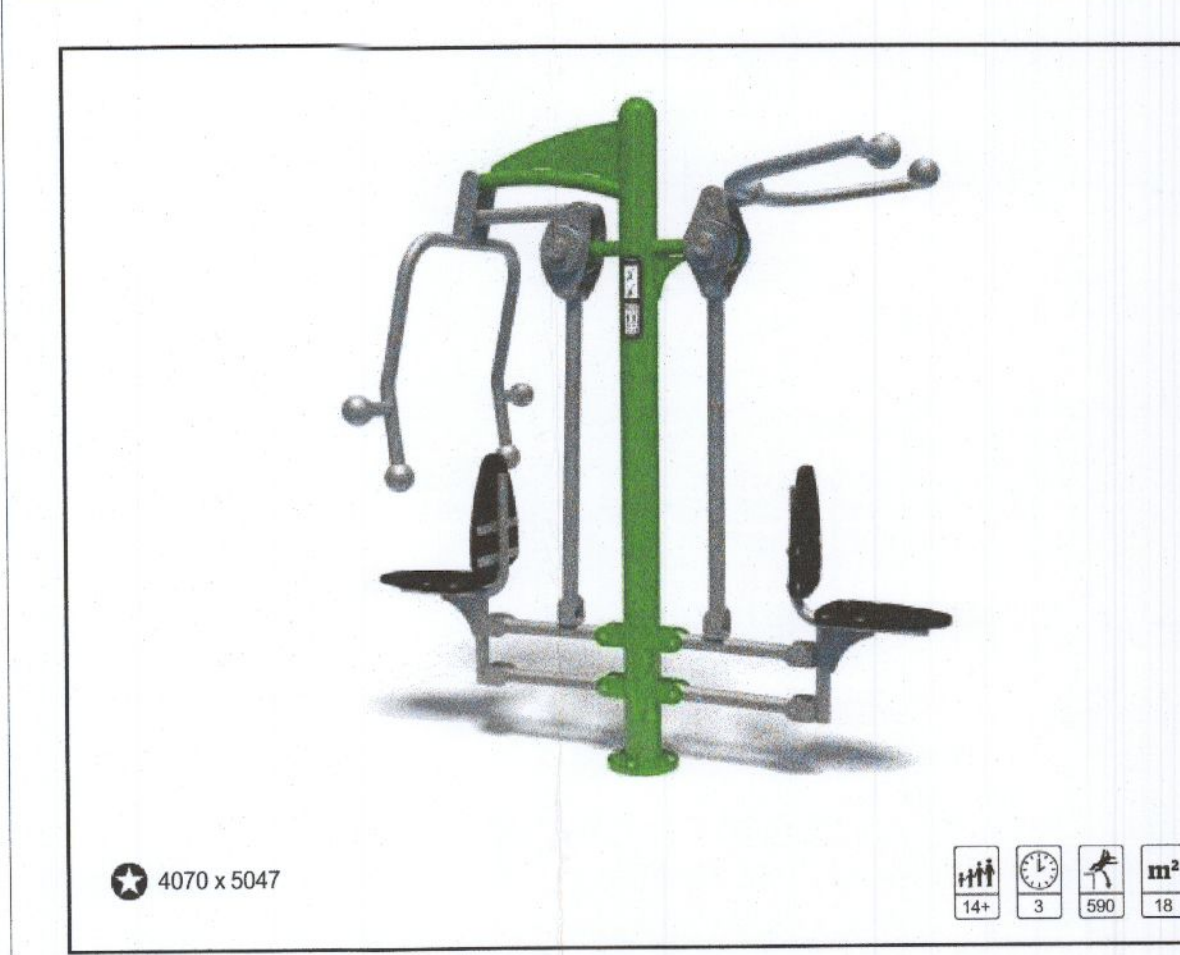

Lat Pull & Chest Press Combo

8054664 CC Green - Cast In Place

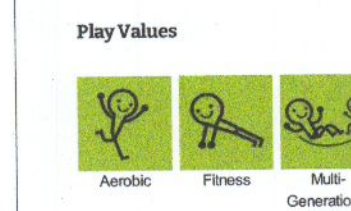

HAGS

2 Outdoor Gym equipment, Lateral Pull and Chest Press



UniPlay Sungam

8071075 S Wooden Posts Green - Surken Foundation

Sungam has various challenge levels and play features such as sliding, jumping and climbing. Children can also opt to just sit back and relax in the hang out spaces and on the Webby relax. With various entry points, explorers can choose to get onto the towers via the curved climb wall, climbing rails, ball climber or webby climb, depending on their ability.

HAGS

3 Play unit, Sungam

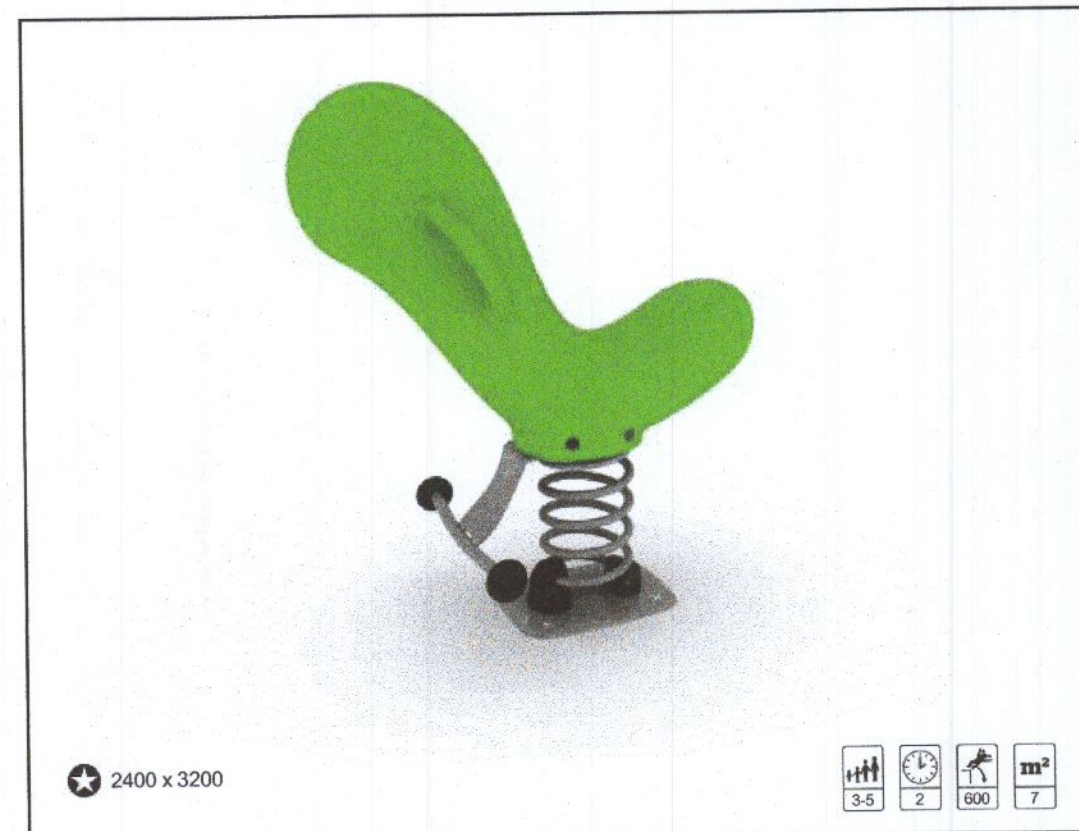

Spring Toy Klump

8052542 S 1 seater Green - Surken Foundation

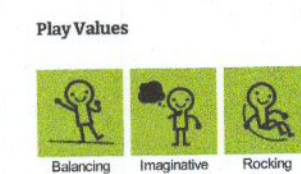

HAGS

4 Play equipment, spring rocker Klump

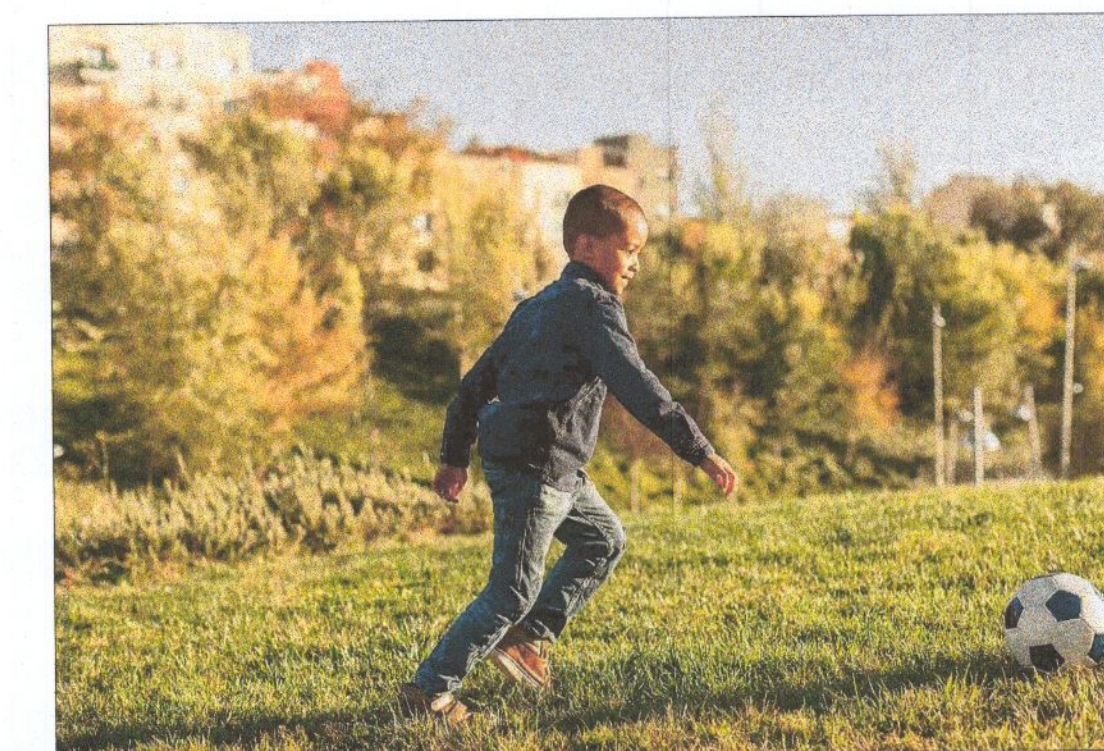

5 Informal kickabout space



Tiger mulch to base of outdoor gym and formal playground equipment

Note 1:
All play equipment to conform to EN 1176-1-11 and 1177 Playground Equipment and surfacing

Note 2:
Surface finished with engineered woodchip conforming to BS EN 1177 Impact attenuating surfacing

Rev.	Date	Note
00	0000-00-00	00

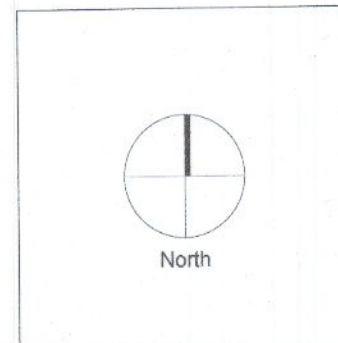

General Notes

Doyle & O'Troithigh Landscape Architecture

Project Name	Tandy's Lane Village Phase 2	Drawing Name	Playground Plan 2 of 3
Status	Further Information	Drawing No	PG-02-FI
Project No	19-044	Revision No	00
Scale	1:200	Drawn By	KGR
Date	29/08/2022	Checked By	DOT

Linda Doyle Director +353 (0)87 207 4196 linda@doyle-otroithigh.com
 Dáithí O'Troithigh Director +353 (0)86 300 3499 doth@doyle-otroithigh.com
 Office Address Penelope House 28-29 Upper Pembroke St Dublin 2
 Contact mail@doyle-otroithigh.com +353 (0)1 608 7782