

# **Arborist Associates Ltd.**

## **An Arboricultural Assessment of the Site Area on 'Clonburris SDZ Lands', Cappagh, Dublin 22.**

**Prepared for: Kelland Homes Ltd. (Planning Applicant)**

**Prepared by: Felim Sheridan F. Arbor. A, RFS Dip, Nat. Dip & NCH in  
Arboriculture**

**Date: 31<sup>st</sup> May 2022**

**94 Ballybawn Cottages, Enniskerry, Co. Wicklow.**

**Tel: 2742011**

**Mobile: 087 2629589**

**Email: arborist@eircom.net**

## 1.0 Instructions

- 1.1 I have been instructed by Kelland Homes Ltd. (planning applicant) to assess the site area on 'Clonburriss SDZ Lands', Cappagh, Dublin 22 and report on the following:
- A - To assess the present condition of the tree vegetation within this site area. See condition tree assessment schedule within 'Appendix 2' of this report and drawing No.CBC001 which has been prepared as a Tree Constraints Drawing for details.
  - B - To assess the impact of the proposed development layout on the tree and hedge vegetation located within the site area indicating those for removal and retention. See 'Section 5' of this report and drawing 'No.CBC002' for detail.
  - C - To show the position of the tree protective fencing and other tree protection measures that will need to be put in place and be maintained in place until all construction works are complete. See 'Section 6.0' of our report, Appendix 1, and 'Drawing No.CBC002' for detail.

## 2.0 Report Limitations

- 2.1 The inspection has been carried out from ground level only and is a preliminary report. It does not include climbing inspections or below ground investigations. Should a more detailed inspection be thought necessary on any tree/s, then this will be highlighted within my recommendations.
- 2.2 The assessment is based on what was visible at the time and recommendations made are subject to the knowledge and expertise of the qualified Arboriculturist that carried out the above inspections.
- 2.3 Trees should be inspected on a regular basis as their health and condition can change rapidly due to biotic and abiotic agents. The recommendations within this report are valid for a 12-month period only and this may be reduced in the case of any change in conditions to or in the proximity of the trees.
- 2.4 Before undertaking any work to these trees, it would be advisable to check whether there is any planning or tree preservation controls are in operation, if they are it will be necessary to obtain consent before undertaking any works (pruning or felling).

## 3.0 Survey Data Collection and Methodology

- 3.1 The Arboricultural data which is presented within the attached tree schedule (see Appendix 2), has been recorded in line with BS 5837:2012. The tree survey was conducted by collecting and assessing the following information on all significant trees located on site and plotted on the land survey map provided.



- Tree Number (metal tags attached to each tree).
  - Tree species both common and botanical.
  - Dimensions (Trunk diameter, height, crown spread and crown clearance).
  - Age Class
  - Physiological Condition
  - Structural Condition
  - Preliminary Recommendations
  - Estimated remaining contribution within their present environment
  - Retention category/category grade
- 3.2 Each tree included within this assessment has been marked with a small aluminum tag with a reference number that relates to the main condition report.
- 3.3 The inspection of the trees involves a visual assessment from ground level only and does not include any invasive means of assessing the trees internally, their below ground parts or the aerial parts that are not visible from the ground. Good, fair and poor have been used to summarize the physiological and structural conditions of these trees with the comments giving more detail. Other items that may limit the assessment of a tree included Ivy cover, scrub vegetation and/or basal suckers.
- 3.4 Their retention category has been assessed and categorized according to their quality and value within the existing context (BS-4.5), and not in conjunction with any proposed development plans. In making this assessment, particular consideration was given to;
- Arboricultural Value:** An assessment of the trees health, structural form, life expectancy, species and its physical contribution to or effects on other features located on site.
- Landscape Value:** An assessment of a trees locality including its contributions to other features as well as to the site as a whole.
- Cultural Value:** Additional contributions made such as conservation, historical or commemorative value.
- 3.5 The trees have been divided into one of the following categories, in accordance with the cascade chart illustrated in table 1 of BS 5837:2012. The classification process begins by determining whether the tree falls within the (U) category, if not then the process will continue by assuming that all trees are considered according to the criteria for inclusion in the high category (A). Trees that do not meet these strict criteria will then be considered in light of the criteria for inclusion in the moderate category (B) and failing this, they will be allocated a low category (C).

**The following summarizes each of the categories:**

**Category U** - Those trees in such a condition that any existing value would be lost within 10 years.

These would be seen as trees that have little or no potential either due to their physiological and/or structural condition and their removal would be seen necessary either now or in the short-term as the most appropriate management option.

Any category 'U' trees identified within this site area have been shown on our drawings (Nos.CBC001 & CBC002) with a 'Red' donut around their trunk positions. Due to the condition of these trees, they should not be considered a constraint on the design layout of the proposed development of this site area.

**Category A** - Trees of high quality/value with a minimum of 40 years life expectancy.

These would be seen as trees that have the potential to contribute to the tree cover of this area for the long-term.

From our assessment of the tree and hedge vegetation within the site area, none have been allocated to this category.

**Category B** - Trees of moderate quality/value with a minimum of 20 years life expectancy.

These would be seen as trees that have the potential to contribute to the tree cover of this area for the medium term.

Any category 'B' trees identified within this site area have been shown on our drawings (Nos.CBC001 & CBC002) with a 'Blue' donut around their trunk positions.

**Category C** - Trees of low quality/value with a minimum of 10 years life expectancy.

These trees would be seen as having the potential to provide tree cover for the short to medium term. As part of the future management, some of these would probably be removed for one reason or another. These trees should not be seen as a considerable constraint on the development of these lands, but should be considered for retention where viable.

Any category 'C' trees identified within the site area have been shown on our drawings (Nos.CBC001 & CBC002) with a 'Grey' donut around their trunk positions.



- 3.6 The trees have been plotted onto the attached drawing (No.CBC001) by a land survey company. This drawing has been developed as a 'Tree Constraints Plan' to aid the design team in the layout of the development and the tag numbers referred to in the condition tree report have been shown on this drawing along with their crown spreads and their retention category colour coded as recommended by BS 5837 2012. The constraint (Minimum Root Protection Area) for each tree has been shown with an 'Orange Circle' and all proposed development should be planned to be positioned outside those trees proposed for retention allowing for additional space for construction activities.

The Root Protection Area (RPA) is the minimum area around individual trees to be protected from disturbance during construction works; RPA is usually expressed as a radius in meters measured from the tree stem.

Any deviation in the RPA from the original circular plot takes account of the following factors whilst still providing adequate protection for the root system:

- a) The morphology and disposition of the roots, when influenced by past or existing site conditions (e.g. the presence of roads, structures, drainage ditches and underground apparatus);
- b) Topography and drainage;
- c) The soil type and structure;
- d) The likely tolerance of the tree to root disturbance or damage, based on factors such as species, age, condition and past management.

#### **4.0 Summary of Survey Findings**

- 4.1 The site area forms part of the larger 'Clonburriss Strategic Development Zone' (SDZ). It is an irregular shaped area bounded by the Ninth Lock Road to the east, the Fonthill Road and train station to the west, a railway line to the north and existing residential development at Whitton Avenue / Cappaghmore Estates to the south. The site boundaries are generally defined by steel railings to the north, east and west and block walls / timber fencing to the south.



Google aerial image shows the site area and the surrounding environment.

- 4.2 The site area consists of a number of unmanaged grassland fields which are separated by the remnants old field hedgerows and field gaps. The remains of an old house are located in the south-eastern corner of the site close to the boundary to the Ninth Lock Road. The hedgerows present are typical agricultural hedgerows for this area forming boundaries with the adjoining lands and properties. There are a number of deep, water filled, drainage ditches associated with the field hedgerows. The hedgerows have been largely unmanaged, but have been subject to recent cutting and clearing works including the clearing of Bramble. The trees on this site are located along the hedge lines and along the southern boundary with the adjacent residential development.
- 4.3 The hedgerows are made up predominantly of Hawthorn and Elder with Bramble and Dogrose bulking up the lower vegetation. The tree species consist mainly of Ash, Sycamore and Oak with some dead Elm present and they range in age from semi-mature to mature and have grown up above the height of the surrounding hedge lines.



- 4.4 Within the overall site area, 43No.Trees were tagged individually (Nos.1795-1837), with 4No.Trees and 5No.Hedges numbered numerically.

<b>Category Grade</b>	<b>No. of Trees</b>
<b>Category U</b> Trees = 4	<b>Trees Nos.</b> 1799, 1814, 1822 & 1836
<b>Category A</b> Trees = 0	<b>Tree Nos.</b> N/A
<b>Category B</b> Trees = 11	<b>Tree Nos.</b> 1805, 1810, 1812, 1815, 1816, 1821, 1823, 1825, 1835, Tree No. 3 & Tree No. 4
<b>Category C</b> Trees = 32	<b>Tree Nos.</b> 1795, 1796, 1797, 1798, 1800, 1801, 1802, 1803, 1804, 1806, 1807, 1808, 1809, 1811, 1813, 1817, 1818, 1819, 1820, 1824, 1826, 1827, 1828, 1829, 1830, 1831, 1832, 1833, 1834, 1837, Tree No. 1 & Tree No. 2
<b>+ 5 Hedges</b>	<b>Hedge Nos.</b> 1, 2, 3, 4 & 5
<b>Totals:</b>	<b>47 Trees + 5 Hedges</b>

## 5.0 Arboricultural Implication Study

5.1.1 Kelland Homes Ltd. seeks permission for development on a site area of 6.3Ha, on lands within the town land of Cappagh, Dublin 22. The proposed development is located west of the Ninth Lock Road, south of the Dublin-Cork railway line, north of Cappaghmore housing estate and Whitton Avenue, and east of an existing car park / park & ride facility at the Clondalkin Fonthill train station and the R113 (Fonthill Road). The proposed development is located within the Clonburris Strategic Development Zone (SDZ), within part of the development areas of Clonburris Urban Centre (i.e. CUC-S4) and Clonburris South East (i.e. CSE-S1 & CSE-S2), as identified in the Clonburris SDZ Planning Scheme 2019.

The proposed development consists of the construction of 294 no. dwellings, crèche and retail / commercial unit, comprised of:

- 118 no. 2, 3 & 4 bed, 2 storey semi-detached and terraced houses;
- 104 no. 2 & 3 bed duplex units accommodated in 10 no. 3 storey buildings;
- 72 no. 1 & 2 bedroom apartments in 2 no. 4 & 6 storey buildings;
- 2 storey crèche (c.500m<sup>2</sup>);
- 1 no. retail /commercial unit (c.150m<sup>2</sup>).

Access to the development will be via the permitted road network (under Ref. SDZ20A/0021) which provides access from the Ninth Lock Road to the east and the R113 (Fonthill Road) to the west. The proposed development will connect into the permitted infrastructural works as approved under the Clonburris Strategic Development Zone Planning Scheme (2019) and permitted under Ref. SDZ20A/0021, with the proposed development connecting into the permitted surface water drainage attenuation systems i.e. 1 no. pond, 3 no. modular underground storage systems and 1 no. detention basin combined with modular underground storage systems. The proposed wastewater infrastructure will connect into a permitted foul pumping station and pipe network within proposed road corridors to facilitate drainage connections to future wastewater drainage infrastructure within the adjoining SDZ lands (including future Irish Water pumping station granted under SDZ21A/0006).

The proposed development also provides for all associated site development works above and below ground, public & communal open spaces, hard & soft landscaping and boundary treatments, surface car parking, bicycle parking, bin & bicycle storage, public lighting, plant (M&E), utility services & 4 no. ESB sub-stations.

This application is being made in accordance with the Clonburris Strategic Development Zone Planning Scheme 2019 and relates to a proposed development within the Clonburris Strategic Development Planning Scheme Area, as defined by Statutory Instrument No. 604 of 2015.



- 5.1.2 This section of our document is designed to assess the impact of the proposed development layout on the tree vegetation within this site area and to look at the necessary measures that will need to be undertaken to help retain the tree and hedge vegetation shown for retention free from adverse impacts for the duration of the construction period.
- 5.1.3 On drawing 'No.CBC002', I have identified the tree vegetation to be removed to facilitate this proposed development and/or as part of management with 'Red Hatched' crown spreads and those to be retained to form part of the long-term tree cover on these lands with a 'Green Hatched' crown spread. The protective fencing has been shown on this drawing using 'Orange Hatching' and this will need to be erected at the start of the works and be maintained in place until all works are completed. This fencing is to protect the root zone of the tree and hedge vegetation being retained and to ensure their successful integration into the development of these grounds.
- 5.1.4 The comments made within this impact assessment study are based on my understanding of the proposed development layout and what is required to allow for its construction.

## 5.2.0 Tree Removal

- 5.2.1 The following table gives a breakdown of the tree and hedge vegetation that will need to be removed to facilitate the proposed development.

Category Grade	No. of Trees
<b>Category U</b> 4 Trees	<b>Trees Nos.</b> 1798, 1814, 1822 & 1836
<b>Category A</b> 0 Tree	<b>Tree No.</b> --
<b>Category B</b> 5 Trees	<b>Tree Nos.</b> 1812, 1821, 1823, 1825 & 1835
<b>Category C</b> 18 Trees +  2 Hedges & c.32 m of sections of other Hedges	<b>Tree Nos.</b> 1795, 1796, 1797, 1798, 1800, 1818, 1819, 1820, 1824, 1826, 1827, 1828, 1829, 1830, 1831, 1832, 1833 & 1834. <b>Hedge Nos.</b> All of hedge Nos. 3 & 4 plus c.32m of Hedge No.1 in varying small sections.
<b>Totals:</b>	<b>27 Trees plus 2 full Hedges &amp; c.32m from other section of Hedging.</b>

- 5.2.2 Under planning reference SDZ20A/0021 granted for the road network to service the Clonburris Strategic Development Zone (SDZ) lands, planning permission was also given for infrastructural works which included three modular underground storage systems and two of these are located one on either side of Hedge No. 1. The storage tank on the west-side of this hedge is not expected to result in a negative impact on this hedge as the root growth in this direction has been restricted by the existing deep wet drainage ditch, but the tank on the east-side will be located within the root zone of Tree Nos.1803 – 1812. Within this



planning application, these trees were shown for retention, but they are likely to be impacted upon by the excavations for this tank and due to the proximity of these works to Tree No.1812, I would now recommend its removal. The remaining trees will need to be fenced off during the construction works and the extent of excavation to install this tank in this area will need to be reviewed on site and kept as steep as possible to reduce the extent of excavation into their root zones which could cause root damage that would be damaging to the health of these trees.

5.2.3 Along the southern boundary, Hedge No.4 and the trees within this hedge are being shown for removal to facilitate the proposed development. While not all the trees within this hedge are directly affected by the proposed layout, some would be located within the rear gardens of these proposed houses, but as they are Ash trees of low quality, they would not be considered retainable given the proneness of Ash to infection by Ash Dieback (*Hymenoscyphus Fraxineus*) which will limit their future potential and their management would be seen as onerous on the perspective house owners, these are also shown for removal now as a result. The removal of this tree and hedge vegetation will allow the drainage ditch to be filled in and new landscape tree planting added to this boundary which will be more appropriate for this new urban environment.

5.2.4 **So in summary**, 27 of the 47No.individual trees surveyed within the survey area, plus two full hedges and c.32m of another hedge made of small sections are being proposed for removal to accommodate the proposed development or as part of active management and this is made up of a mix of tree species, age classes and sizes. See 'Appendix 2' of this report for full details on tree and hedge vegetation.

**The trees for removal are broken down into the following category grades:**

- 4No. of the 4No. Category 'U' trees = 100%.
- 0No. Category 'A' trees.
- 5No. of the 11No.Category 'B' trees = 45.4%.
- 18No. of the 32No. Category 'C' trees = 56.2%.

5.2.5 The loss of the above tree and hedge vegetation is to be mitigated against within the landscaping of this completed development with the use of trees, shrubs, hedging, herbaceous and bulb planting.

This planting as part of the landscaping will complement the development and its incorporation into the surrounding area. It will also help to provide good quality and sustainable long-term tree cover and as it establishes and grows in size, it will be continuously mitigating any negative impacts created with the loss of the existing tree vegetation to facilitate the proposed development. See landscape architects drawings and schedules for detail.

The design of the landscape areas within the completed development is focused on tree and hedge planting as mitigation for the existing tree and hedge vegetation loss particularly along the boundaries. A mix of tree species, forms



and sizes including the use of semi- mature trees will form a strong and unifying element to the landscape areas.

**The planting strategy key factors are to:**

- Create a sense of identity using trees
- Create a robust landscape that performs all year round and is suitable for the current proposed use of these lands
- Use vegetation to screen and enhance views
- Use a more diverse mix of plant species that are good pollinators
- Plant robust species that tolerate drought and site-specific micro-climates
- Plant species that are maintenance friendly

**5.3.0 Tree Retention**

- 5.3.1 For those trees and hedges proposed for retention, all necessary mitigation measures will need to be put in place in order to prevent or reduce impact to its very minimum. Mitigation measures used will need to include the erection of protective fencing at the very start of the works, ground protection installation within root zones where fencing cannot be erected to enclose the entire root zones, monitoring of the site works by the project Arboriculturist throughout the construction process and the use of tree friendly techniques and products for the construction process.

## 5.3.2 Main items for consideration during the proposed construction process:

Item	Comments
<b>Tree Pruning</b>	<p>As part of the initiating works, the crowns of some of the trees are to be pruned to remove dead/unstable growth, as well as the pruning of individual limbs/branches or entire crowns to reduce size due to structural weaknesses or to improve their juxtaposition within the built environment. A preliminary list of these works is given within the condition tree assessment in 'Appendix 2' of this report and these are to be reviewed on site prior to being carried out.</p> <p>The hedges being retained in most instances will require trimming to bring them back into active management and to incorporate them into the completed landscaped development. This will involve trimming in of their sides, particularly excessive spread of vegetation especially Bramble and the poorer structured sections will need trimming/pruning to address stability issues. The objective of the trimming of the hedges is to help rejuvenate them with the encouragement of lower growth development and once trimmed back; there will be an opportunity to augment poor quality sections with new hedge planting to create better structured sustainable hedges for the future suitable for their new built urban environment.</p> <p>All tree felling and pruning work should be carried out by qualified and experienced tree surgeons <i>before</i> any construction work commences; all tree work should be in accordance with <i>BS3998 (2010) Tree Work – Recommendations</i>.</p> <p>For the stumps of trees that need to be removed, particularly those which are located within the root zone of trees being retained, these are to be ground out using a mechanical stump grinder taking care not to cause root damage to the trees being retained.</p>
<b>Tree Management</b>	<p>Within the proposed development, as is the current situation, trees will be positioned within close proximity to buildings and usable surfaces such as roads and neighbouring properties. As a result, it will be necessary to continue to review the condition of these trees on a regular basis and to carry out any necessary remedial tree surgery works required to promote health and safety. This will involve the ongoing monitoring of the Ash trees retained for infection and decline as a result of 'Ash Dieback' and the necessary management will need to be undertaken to address safety.</p> <p>Any new tree planting carried out will require maintenance to encourage good growth habits and to alleviate any safety concerns that they may present as they grow in size.</p>



Item	Comments
<b>Tree Protection</b>	<p>Trees being retained will need to be protected from unnecessary damage during the construction process by effective construction-proof barriers that will define the limits for machinery drivers and other construction staff.</p> <p>Ground protected by the fencing will be known as the 'Work Exclusion Zone' and sturdy protective fencing will need to be erected along the points identified in the Tree Protection Plan (DWG No. CBC002) prior to any soil disturbance and excavation work starting on site. This is essential to prevent any root or branch damage to the retained trees. The British Standard BS5837: <i>Trees in relation to design, demolition and construction (2012)</i> specifies appropriate fencing, see appendix 1 for details. All weather notices should be erected on the fences with words such as: "Tree Protection Fence — Keep Out".</p> <p>When the fencing has been erected, the construction work can commence. The fencing should be inspected on a regular basis during the duration of the construction process and shall remain in place until heavy building and landscaping work have finished and its removal is authorised by the project Arboriculturist.</p>
<b>Construction</b>	<p>It will be important that good housekeeping is in place at all times so that the site does not become congested.</p> <p>All construction works are to be well planned in advance so as not to put pressure on the protective zone around the trees. All works are to occur from outside the protective zones.</p> <p>Where work space between the building lines and the protective fence lines is limited/ restricted, alternative work methods will need to be looked at so as to keep the work areas to their minimum in order to reduce the extent of soil and root damage occurring to the trees proposed for retention. See section 6.2.3 of BS5837 2012 for detail on working within the RPA and ground protection. For light access works within the work exclusion zone, the installation of suitable ground protection in the form of scaffold boards, woodchip mulch or specialist ground protection mats/plates may be acceptable. These are to be reviewed with the project Arboriculturist and installed to their recommendations. See detail in 'Appendix 1' of this report for sample of ground protection for light weight construction works.</p> <p>Care should be taken when planning site operations to ensure that wide or tall loads or plant machinery with booms, jibs and counterweights can operate without coming into contact with retained trees. Such contact can result in serious damage to them and might make their safe retention impossible.</p>



Item	Comments
	<p>Materials, which can contaminate the soil, e.g. concrete mixings, diesel oil and vehicle washings, should not be discharged within 10m of a tree stem.</p> <p>Fires should not be lit in a position where their flames can extend to within 5 m of foliage, branches or trunk. This will depend on the size of the fire and the wind direction.</p> <p>Notice boards, wires and such like should not be attached to any trees. Site offices, materials storage and contractor parking should all be outside the work exclusion zone.</p>
<b>Services</b>	<p>Services entering and leaving the site area are routed so they are located outside the root protection zones of the trees to be retained.</p> <p>Prior to the installation of any services routed near trees, these are to be marked out on site for review by the project Arboriculturist and a detailed method statement is to be prepared by the installation contractor in conjunction with the project Arboriculturist on how these services are to be installed while providing protection to the surrounding tree vegetation shown for retention.</p>
<b>Landscaping</b>	<p>The existing ground levels within the RPA of the trees are to be retained and incorporated into the finished landscaped development. Where changes in levels occur, these are to be either graded into the finished levels starting outside the RPA or alternatively, retaining wall structures are to be used differentiating between the different levels.</p> <p>All soft and hard landscaping within the RPA of the trees to be retained are to be carried out manually and the soil levels are not to be lowered or raised resulting in root damage to the trees. All surfaces are to be porous to allow the free movement of air and moisture to the roots below. Recommendations of sections 8 of BS5837 2012 are to be adhered to during the landscaping within the RPA's of these trees.</p> <p>In some places, paths/surfaces will encroach into the root zone of the tree vegetation to be retained and these sections of paths and surfacing will need to be installed using a 'No-Dig' method over the existing ground levels to avoid causing damage to the soil and roots underneath. Where it is necessary to provide extra support for heavier loading, it will be important to use a cellular confinement system such as 'CellWeb' within the construction of these sections of paths/surfaces. See 'Section 6.8.0' of our report for general detail on the installation of such product and the guidance of the Arboricultural Practice Note 12 'The use of cellular confinement systems near trees' A guide to good practice'.</p>
<b>Boundary Treatments</b>	<p>The boundary treatments within the root zone of the tree and hedge vegetation being retained are of a fence type structure where there will only be a need to dig small diameter holes for the</p>



Item	Comments
	<p>uprights. These holes for the uprights are to be dug manually with no machinery allowed inside the root protection areas. Work zones within the root protection areas for these trees will need to be protected during the construction of the boundary fences by boarding as per section 6.2.3 of BS 5837 2012.</p> <p>Where it is needed to install fences along existing hedges, it will be necessary to carry out some pruning of the side vegetation to allow access. This is to be kept to a minimum and where necessary, the hedges are to be augmented with new hedge planting to fill openings and to bulk up screening.</p>

#### 5.4.0 Monitoring

- 5.4.1 Any construction works within close proximity to retained trees are advised to be undertaken in accordance with approved method statements prepared by the construction contractor under the direct supervision of a qualified consultant Arboriculturist. Therefore, during the construction works, a professionally qualified Arboriculturist is recommended to be retained by the principal contractor or site manager to monitor and advice on any works within the RPA of retained trees to ensure successful tree retention and planning compliance.
- 5.4.2 It is advised that tree protection fencing, any required special engineering and supervision works must be included in the main tender documents, including responsibility for the installation, cost and maintenance of tree protection measures throughout all construction phases.
- 5.4.3 Copies of the tree retention and protection plan (DWG No. CBC002) a copy of BS 5837(2012) and NJUG 4 (2007) should all be kept available on site during the construction works and all works are to be in accordance with these documents.
- 5.4.4 On the completion of the construction works, all trees retained are to be reviewed by the project Arboriculturist and any necessary remedial tree surgery works required to promote the health of the trees and safety are to be implemented.

## **6.0 Arboricultural Method Statement/Tree Protection Strategy**

- 6.1 The objective of this arboricultural method statement/tree protection strategy is to provide information for the main building contractor/site manager on how trees need to be protected during a construction project and so that they can prepare their own site specific detailed method statement for their works.
- 6.2 It is necessary for tree protective fencing to be erected and all other mitigation measures required to be put in place prior to the development works commencing on site and these are to enclose and protect the root zone of the tree vegetation proposed for retention. See drawing DWG No.CBC002, for the position of the protective fencing and other mitigation measures.
- 6.3 The protection of the tree vegetation shown for retention is divided into three main sections starting with the preconstruction stage right through to post construction and the reassessment of the retained trees.



## **Stage 1:**

### **6.4.0 Pre-Construction Works**

6.4.1 Prior to the main construction works commencing on site the following needs to be planned:

1. The developer or main contractor needs to appoint an Arboriculturist for the duration of the project. The Arboriculturist is to make regular site visits to ensure that the tree protection measures are in place and adhered to.
2. The main contractors and all sub-contractors work force are to be briefed on the tree protection and ensure that these measures are to be kept in place throughout the construction period.
3. All personnel are to adhere to the recommendations of the appointed Arboriculturist.
4. Any issues in relation to the trees shown for retention must be discussed with the appointed project Arboriculturist and the necessary mitigation measures put in place without delay and prior to the works being carried out.

### **6.5.0 Site Meeting**

6.5.1 Prior to any works commencing on site, it is necessary that a meeting be arranged between the project manager, site foremen, the project Arboriculturist and local authority to identify and finalize the trees for removal and the line of the protective fencing.

### **6.6.0 Tree Works**

6.6.1 The developer or the main contractor is to appoint a tree surgery company competent of carrying out the remedial tree surgery works and tree felling that are required on this site. The tree surgery contractor is to produce a method statement detailing how he plans to undertake the works and informing the site foreman of the process so the necessary steps can be taken to ensure the works are carried out safely and efficiently. The works are to be carried out by appropriately trained personnel taking account of the recommendations of BS3998 2010.

6.6.2 **Tree removal** - Trees for removal are to be identified by the project Arboriculturist and the method of removing the stumps is to be carried out to the recommendations of the project Arboriculturist. The trees in the way of the works are to be removed in such a manner not to cause damage to those being retained. Where necessary to avoid damage to the trees to be retained, these are to be removed in sections by a tree surgeon (Arborist). Where necessary, the roots and stumps are to be dug out with a digger except where the stumps are located within the RPA (root protection area) of trees being retained. In this instance, the stumps are to be ground out with a mechanical stump grinder taking care not to cause damage to the roots of trees being retained.

6.6.3 **Remedial tree surgery works** - The necessary remedial tree surgery works required to promote health and safety of the trees to be retained is to be carried out. A schedule of these works is to be produced by the project Arboriculturist taking into consideration the trees within their new built environment and prior to these works being carried out; they are to be agreed with the local authority.

#### 6.7.0 **Erection of the protective fencing**

6.7.1 Once the trees have been removed, the line of the protective fencing that is required around the trees being retained **must be** erected as per DWG. No. CBC002.

6.7.2 The fencing needs to be 2.3m high and constructed in accordance with figure 2 of BS 5837 2012 (see fencing detail on drawing No. CBC002 & Appendix 1) using vertical and horizontal scaffold bars well braced together with the verticals spaced out at a maximum of 3m centres. Onto this, weld mesh panels are to be securely fixed with wire or scaffold clamps.

6.7.3 Signs need to be attached to these fences warning people to 'keep out'. See detail within drawing No.CBC002 & Appendix 1.

6.7.4 Once the protective fence line is erected, then the main construction works can commence on site.

6.7.5 **Storage of Material, Work Yards and staff car parking** - These areas **must be** identified on the work drawings prior to the construction works starting. These must be positioned outside the root protection areas around the trees being retained.

#### 6.8.0 **Ground Protection Installation for Pathways and Working Areas**

6.8.1 The ground protection is to take the form of a product such as 'Cell Web' and this will need to be installed in the following manner under the guidance of the project Arboriculturist and engineer:

**Step 1** - The existing ground cover vegetation (e.g. grass/weeds) if necessary is to be killed off using an appropriate herbicide (see Pesticides Handbook [15]). Herbicides that can leach through the soil, e.g. products containing sodium chlorate, are not to be used.

**The soil surface is not to be excavated to establish a sub base for the finished surfaces.**

Loose organic matter, woody vegetation and/or turf are to be removed carefully using hand tools.



If there is a delay in installing the surface following clearing, the soil surface once prepared is to be covered immediately either with hessian sacking or plastic to prevent the surface drying out until the new surface is installed.

**Step 2** – Place the geotextile separation filtration layer over the prepared ground surface. Use a Fibretex F4M non-woven geotextile with dry joints overlapping by 300mm.

**Step 3** – Place constraints along the edges to contain the fill material. These can be of such material as treated timber or railway sleepers.

**Step 4** – Place the required cellular confinement system (Cell Web150-200mm) over the geotextile and pin/anchor the cell walls open for infilling.

**Step 5** – Place the infill material of a 20-40mm clean sharp stone in the open cells of the Cell Web pushing the infill ahead of you so that the machinery is driving on the filled Cell Web. Compact the infill material to the desired density.

**Step 6** – Slightly surcharge the Cell Web product with 25mm of 40/20mm clean angular stone.

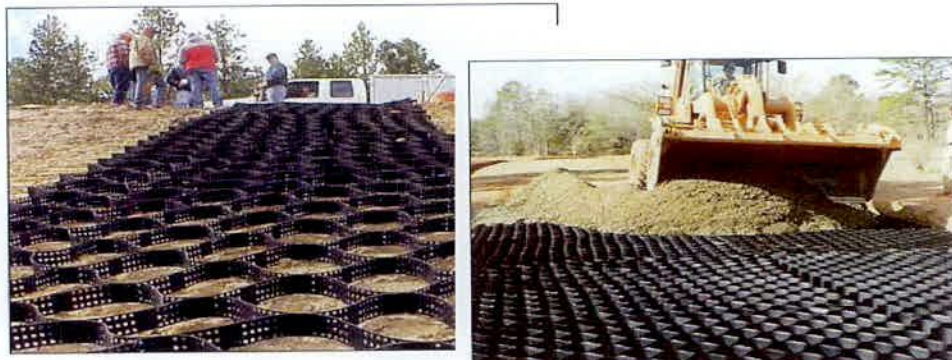

**Pictures show the Cell Web being installed on the ground.**

The below diagram shows how the Cellular confinement system should be installed.

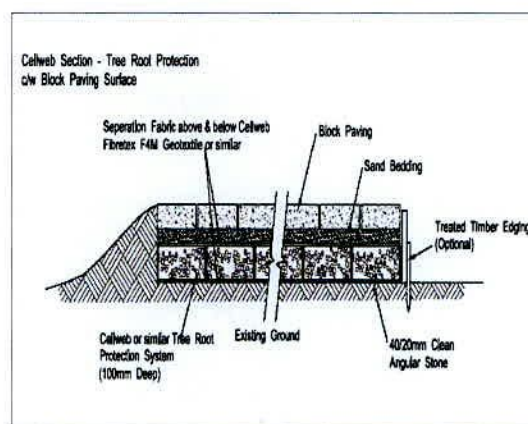
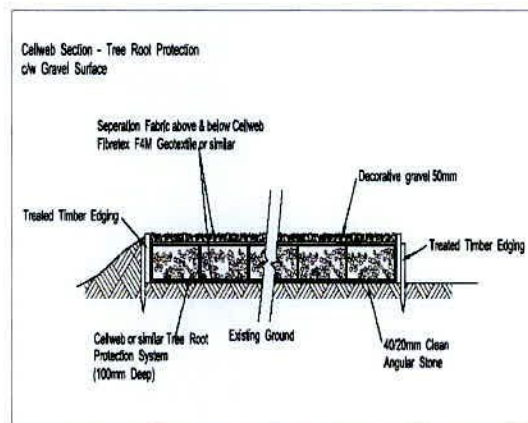



## Stage 2:

### 6.9.0 The Construction Works Stage

- 6.9.1 **Protective fencing** - During the course of the works, special attention must be paid to ensure that these tree protection measures are kept in place, in good order and remain upright, rigid and complete at all times. They must be checked daily by the main contractor/foreman and any damage noted must be fixed immediately.

If works need to take place inside the protective fence lines, then the project Arboriculturist must be informed in advance of the works taking place and the mitigation measures required to reduce impact on the tree vegetation agreed. These mitigation measures will include the supervisions of these works by the project Arboriculturist.

The protective fencing and all other protection measures are to remain in place throughout the construction works phase and must only be removed when all the works are complete and at this stage incorporated into the finished landscape.

- 6.9.2 **Excavations** - The excavation works are only to commence once the protective fence line and all other protection measures are in place.

The excavations in the vicinity of the tree vegetation being retained will need to be viewed on site once marked out with the project manager, site foreman and the project Arboriculturist in advance of excavation to determine the extent of the impact and the work space required to allow for the construction works to proceed and to assess what additional mitigation measures will be required to protect those trees to be retained. In certain areas, it may be necessary to use an alternative method of excavating to prevent encroachment into the RPA of the trees to be retained and this may include such methods as retaining walls or similar.

No roots are to be severed by the construction works without prior approval by the project Arboriculturist. Where roots are encountered, the project Arboriculturist is to assess these prior to cutting and these are to be pruned back to appropriate pruning points beyond the excavation line. Where roots cannot be cut; alternative methods of construction will need to be considered. The excavated face is then to be covered with soil or with Hessian sacking to prevent further drying out and the death of root material. Where the Hessian sacking is used, it will be necessary to keep this moist especially during dry periods.

- 6.9.3 **Working within the RPA (Root Protection Area)** – If it becomes necessary to carry out works within the RPA of a tree/trees, these must be discussed and agreed with the project Arboriculturist. All works must be carried out manually. Root pruning is to be undertaken by an Arboriculturist using proprietary cutting tools such as a secateurs or hand pruning saw.

The ground within the RPA of the trees must be protected from damage as per the recommendations of **section 6.2.3** of BS5837 2012. See detail within appendix 1 on ground protection using boarding for pedestrian loading.

- 6.9.4 **Finished ground levels/Landscaping** - The existing ground levels within the RPA of trees must be retained and incorporated into the finished landscaped development. Where changes in levels occur, these are to be either graded into the finished levels starting outside the RPA or alternatively, retaining wall structures are to be used differentiating between the different levels.

All soft and hard landscaping within the RPA of the trees to be retained must be carried out manually and the soil levels must not be lowered or raised resulting in root damage to the trees. All surfaces are to be porous to allow the free movement of air and moisture to the roots below. Recommendations of sections 8 of BS5837 2012 must be adhered to during the landscaping within the RPA of the trees being retained.

#### 6.10.0 Other items

- 6.10.1 The following is a list of additional activities **that are not allowed** within the RPA or within the vicinity of the trees being retained.

- 1 - Storage of equipment, fuel, construction material, or the stockpiling of soil or rubble.
- 2 - Burning rubbish
- 3 - The washing of machinery
- 4 - Attaching notice boards, cables or other services to any part of the tree.
- 5 - Using neighbouring trees as anchor points.
- 6 - Care is required when using machinery such as Tele-porters, cranes or other equipment close to trees so as not to damage the crown or any other parts.



### Stage 3:

#### 6.11.0 Post Construction Works

6.11.1 This project is not to be considered complete until all retained trees have been re-examined by the project Arboriculturist and the remedial works necessary to ensure the health of the trees and the immediate safety of the end user of this development are implemented.

This report has been produced as part of a planning application for this site area and is for the sole use of the above named client and refers to only those trees and hedgerows identified within. Its use by any other person(s) in attempting to apply its contents for any other purpose renders the report invalid for that purpose.

Signed *Felim Sheridan*

Date 31/05/2022

**Felim Sheridan**

F. Arbor. A, RFS Dip, Nat. Dip & NCH in Arboriculture

**Felim Sheridan's qualifications:**

Fellow of the Arboricultural Association (F. Arbor. A), Professional diploma Arboriculture (RFS), National diploma Arboriculture (ND) and National certificate Horticulture (NCH).

# **Appendix 1**

## **Sample of Temporary Tree Protection Fencing Detail and Ground Protection.**



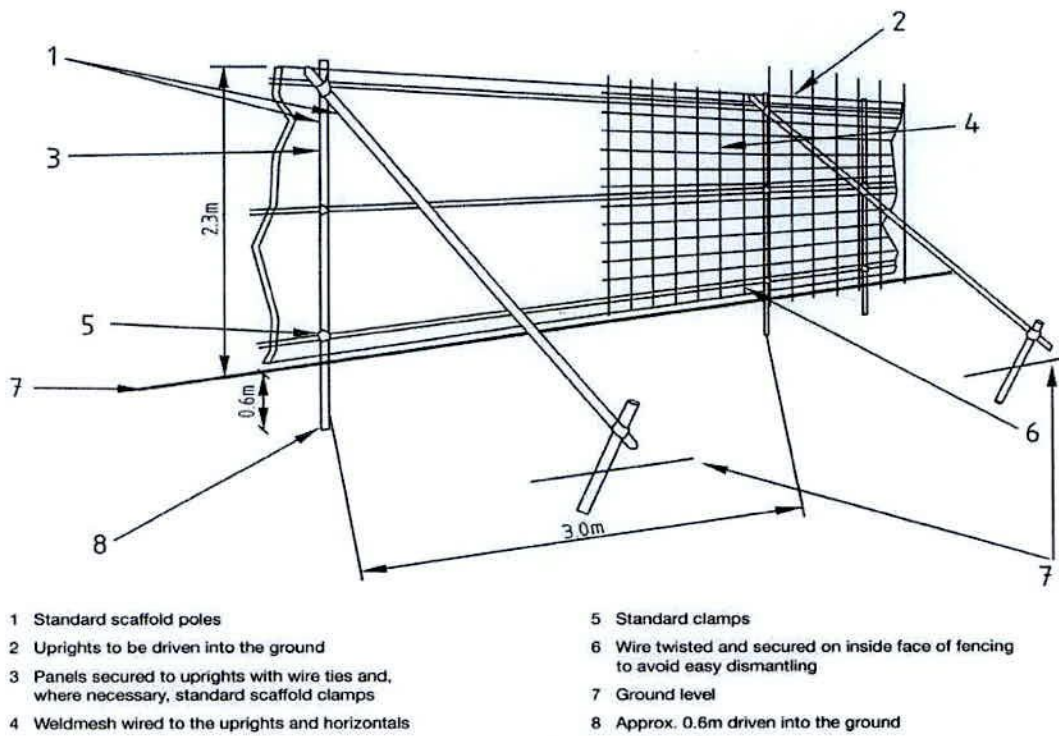
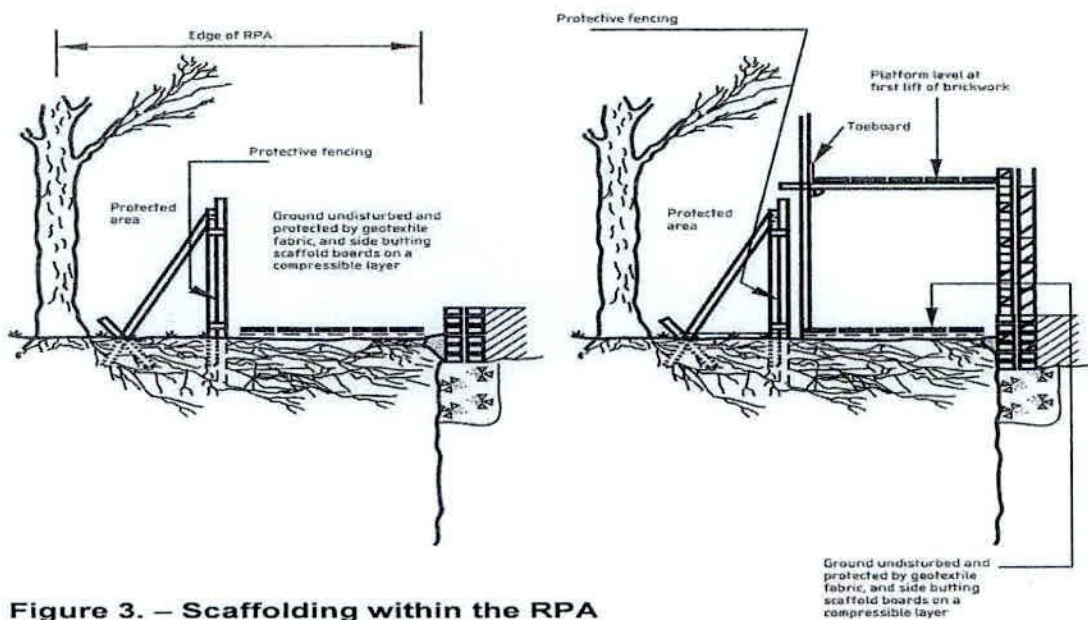

Figure 2. – Protective fencing for RPA



**Sample of signage to be placed on fence panels.**

**Samples of Ground protection**



**Figure 3. – Scaffolding within the RPA**

**Cellular confinement system such as Cellweb to protect root zone.**

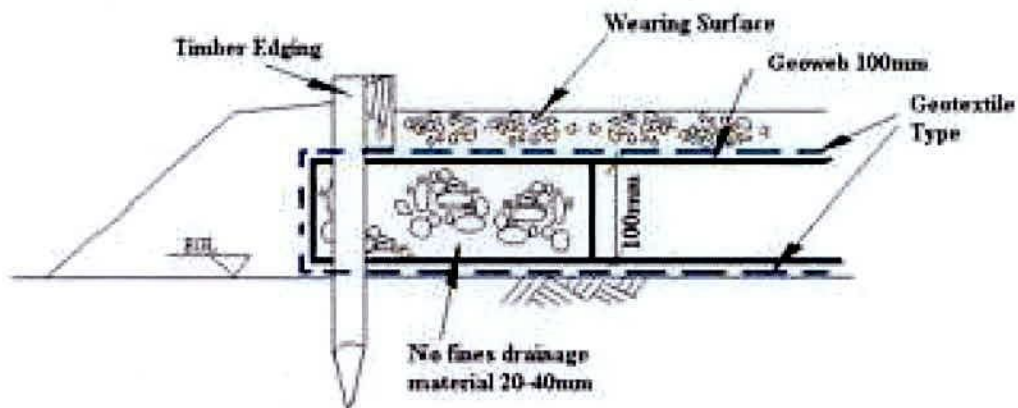



**Example of use of steel/road plates over root area.**

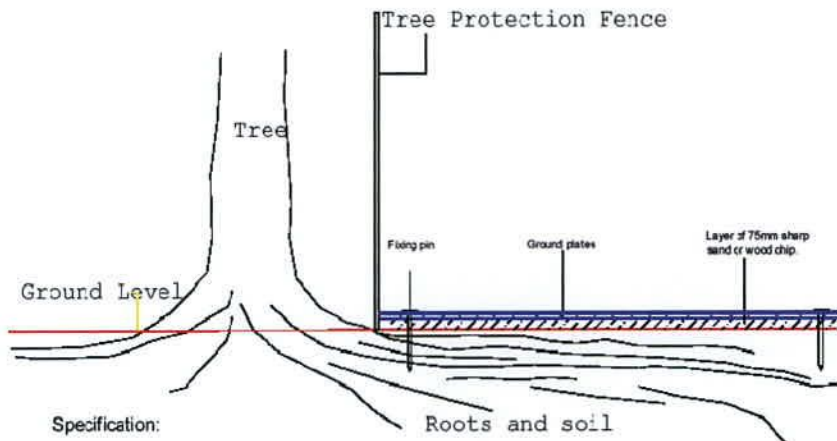

**Specification:**

1. Lay mn. 75m depth of sharp sand/wood chip over identified ground area
2. Lay side-butting scaffold boards/15mm poly propylene road plate over sand/wood chip
3. Fix ground protection cover into place with pins/pegs



**Example of use of steel/road plates over root area.**

# **Appendix 2**

## **Condition Tree Assessment**

**Site Area on  
'Clonburris SDZ Lands', Cappagh, Dublin 22.**

Date: 5<sup>th</sup> April 2022



## Survey Notes

**All codes referred to in this report are approximate and serve as a general guide only.**

**Reference to Numbers:** The trees have metal tags attached and these correspond with the numbers in this report.

**Reference to age class is as follows:**

<b>Young:</b>	A tree, which has been planted in the last 10 years.
<b>Semi Mature</b>	A tree that is less than 1/3 the expected height of the species in question.
<b>Early Mature:</b>	A tree, which is between a 1/3 and 2/3's the expected height of the species in question.
<b>Mature:</b>	A tree that has reached the expected height of the species in question, but still increasing in size.
<b>Over Mature:</b>	A tree at the end of its life cycle and the crown is starting to break up and decrease in size.

**Reference to Physiological, Structural Condition and other comments:**

### **Physiological Condition**

- Good:** A tree with no major defects, but possibly including some small defects.
- Fair:** A tree with some minor defects such as bark Wounds, isolated decay pockets or structure affected due to overcrowding.
- Poor:** A tree with more serious defects such as extensive deadwood, decay or defective to the point of being dangerous.

### **Structural condition and other comments –**

This records noted visual defects and other information about the trees health and structure.

### **Estimated Remaining Contribution in years**

This is based on an Arboricultural assessment of the tree and is estimated based of the findings noted at time. Trees still need to be reviewed on a regular basis, preferably annually.

- Less than (<) 10 years remaining contribution
- 10 + years remaining contribution
- 20 + years remaining contribution
- 40 + years remaining contribution.

## Retention Categories

The purpose of the tree categorization method is to identify the quality and value of the existing tree stock, allowing informed decisions to be made concerning which trees should be removed or retained should development occur.

It is carried out in accordance with section 4.5 (Tree Categorization Method) of BS 5837 2012.

## Summary

### **Main categories**

**Category U** – Those trees in such a condition that any existing value would be lost within 10 Years. Most of these will be recommended for removal for reasons of sound Arboricultural practice.

**Category A** - Trees of high quality/value with a minimum of 40 years life expectancy.

**Category B** – Trees of moderate quality/value with a minimum of 20 year life expectancy.

**Category C** – Trees of low quality/value with a minimum of 10 years life expectancy

### Sub categories

1 – Mainly Arboricultural Values

2 – Mainly Landscape values

3- Mainly Cultural and conservation value

**Note:** Whilst C category trees will usually not be retained where they would impose a significant constraint on development, young trees with a stem diameter of less than 150mm should be considered for relocation.

If a layout design places Category U trees in an inaccessible location such that concerns over public safety are reduced to an acceptable level, it may be preferable or possible to defer the recommendation to fell.

The terms 'Group, woodland or tree line' is intended to identify trees that form cohesive Arboricultural features either aerodynamically (e.g. trees that provide companion shelter), visually (e.g. avenues or screens) or culturally including for biodiversity (e.g. parkland or wood pasture), in respect to each of the three subcategories.

### ***Reference to Crown spread, Height and Trunk Diameter:***

This gives a **guide** to the area taken up by the tree.



**Trunk diameter** is the diameter of the main trunk taken at a height of 1.5m and is recorded in millimetres (mm).

**Height** records the overall height of the tree and is given in meters (m).

**Crown Spread** records the extent of the branches normally in a north, south, east and west direction from the base of the tree and is given in meters (m).

**Clear crown height** records the distance between the ground and the first branch from the base of the tree and is given in meters (m)



Tree No.	Tree Species	Ht. (m)	Stem Dia. (mm)	Branch Spread (m)				C-Ht. (m)	Age Class	Phys Con.	Structural Condition Other Comments	Preliminary Recommendation	Remain Contribute in years	Cat. Grade	
				N	S	E	W								
				N	S	E	W				N=North S=South E=East W= West Phys Con. = Physiological Condition.	A= Average C-Ht= Crown Height			
<p>A Condition Assessment of the tree and hedge vegetation within the Site Area on 'Clonburris SDZ Lands', Cappagh, Dublin 22.</p> <p>The survey commences on the southern boundary adjacent to 'Whitton Avenue' and proceeds in a broadly east to west direction following the hedge lines.</p>															
<p>Recent clearing works have removed all but one of the trees along this boundary. Associated hedgerow material has also been removed. The single remaining tree, Tree No. 1975, has been left isolated. Trees and hedge lines have also been removed around the remains of the old building.</p>															
															
1795	Oak <i>Quercus robur</i>	17	820	7	4	4	4	5	Mature	Fair	Fair/ Poor Originally it formed part of tree and hedge line located along the southern boundary with Whitton Avenue. The rest of the tree and hedge line has been removed leaving this tree in isolation. It leans out to the north before straightening up. It	Cut Ivy at ground level.  Remove dead/ unstable growth and carry out pruning to help address imbalance and exposure	10-20	C2	

Tree No.	Tree Species	Ht. (m)	Stem Dia. (mm)	Branch Spread (m)				C-Ht. (m)	Age Class	Phys Con.	Structural Condition Other Comments	Preliminary Recommendation	Remain Contribute in years	Cat. Grade
				N	S	E	W							
										<b>N=North S=South E=East W= West</b> <b>Phys Con.</b> = Physiological Condition.	<b>A= Average</b> <b>C-Ht= Crown Height</b>			
										has an asymmetric crown, weighed out to the north due to previous competition. Ivy growth extends high into the crown, increasing the crowns wind sail. There is a broken branch on the east side at c.5m which is hanging down. There are signs of past storm damage on the north side at c.2.5m. The crown contains dead wood and branch stubs. The root zone on the south side has most likely been impacted in the past by constructions works for the roadway and boundary railings and the ground levels have been raised.	by the loss of neighbouring trees and hedge vegetation.  Review again in twelve months.			
Hedge No. 1	<b>Hawthorn</b> <i>Crataegus monogyna</i> <b>Privet</b> <i>Ligustrum sp.</i> <b>Elder</b> <i>Sambucus nigra</i> <b>Ash</b> <i>Fraxinus excelsior</i> <b>Sycamore</b> <i>Acer pseudoplatanus</i> <b>Bramble</b> <i>Rubus fruticosus</i>	<b>It extends at ninety degrees from the southern boundary and extends in a generally northward direction, forming a subdivision within the site area.</b>  It is of a mature age class in fair condition both physiologically and structurally. The southern part consists of isolated clumps of Hawthorn with Bramble colonizing in places. It has been allowed to grow unmanaged for some considerable time. Seedling trees of Ash and Sycamore are beginning to develop above the hedge line. There have been recent tree removals at the southern end. The northern part of the hedge is more continuous and has recently been cut down to current height and spread. The southern part of the hedge line is bounded to the west by a water filled ditch.								It would benefit from cutting to selected height and width to shape and tidy and from infill planting of hedgerow species to thicken.  Control spread of Bramble	C2			
		A3.0					A2E, A2W	-						
		<b>It contains the following trees.</b>												



Tree No.	Tree Species	Ht. (m)	Stem Dia. (mm)	Branch Spread (m)				C-Ht. (m)	Age Class	Phys Con.	Structural Condition Other Comments	Preliminary Recommendation	Remain Contribute in years	Cat. Grade
				N	S	E	W							
											<b>N=North S=South E=East W= West</b> <b>Phys Con.</b> = Physiological Condition.	<b>A= Average</b> <b>C-Ht= Crown Height</b>		
1796	<b>Ash</b> <i>Fraxinus excelsior</i>	14	320	3	6	3	4	7	Early Mature	Fair	Fair/ Poor A single stem tree, it has up grown up with Tree Nos. 1797& 1798 and has been drawn up for light affecting its structure. It is growing up on a small bank at the base of the boundary wall to the east. It has no long- term potential in this location.	Retain for now as part of the bulking of this area.	10+	C1
1797	<b>Sycamore</b> <i>Acer pseudoplatanus</i>	13	180/ 200/ 190/ 210	2	3	4	5	3	Early Mature	Fair	Fair / Poor A multi-stem tree from the base, it has grown up with Tree Nos. 1796 &1798 and it has been drawn up for light affecting its structure. It is growing up on a small bank at the base of the boundary wall to the east. It has no long- term potential in this location.	Retain for now as part of the bulking of this area.	10+	C1
1798	<b>Sycamore</b> <i>Acer pseudoplatanus</i>	12	280	2	3	4	2	7	Early Mature	Fair	Fair A single stem tree and it has grown up with Tree No. 1797. It is growing on a small bank at the base of the boundary wall to the east. It has been drawn up for light affecting its structure. It has no long- term potential in this location.	Retain for now as part of the bulking of this area.	10+	C1
1799	<b>Elm</b> <i>Ulmus sp</i>	12	300	3	2	4	2	3	Early Mature	Dead	Poor A group of stems standing dead in the hedge line, most likely killed by 'Dutch Elm Disease' ( <i>Ophiostoma</i> spp.).	I would recommend <b>removal</b> as part of management.	<10	U
1800	<b>Ash</b> <i>Fraxinus excelsior</i>	12	340	4	4	2	2	3	Early Mature	Fair	Fair/ Poor Most likely a self-sown seedling and it has grown up above the hedge line. It has been drawn up for light affecting its structure.	Retain for now as part of the bulking of this area.	10-20	C1
1801	<b>Ash</b> <i>Fraxinus excelsior</i>	14	460	5	6	4	5	3	Early Mature	Fair	Fair It is growing out of the base of a shallow ditch. Ivy	Cut Ivy at ground level.	10-20	C1



Tree No.	Tree Species	Ht. (m)	Stem Dia. (mm)	Branch Spread (m)				C-Ht. (m)	Age Class	Phys Con.	Structural Condition Other Comments	Preliminary Recommendation	Remain Contribute in years	Cat. Grade
				N	S	E	W							
											<b>N=North S=South E=East W= West</b> <b>Phys Con.</b> = Physiological Condition.	<b>A= Average</b> <b>C-Ht= Crown Height</b>		
											growth extends high into the crown increasing the wind sail. The crown contains minor dead wood.	Retain for now as part of the bulking of this area.		
1802	<b>Ash</b> <i>Fraxinus excelsior</i>	13	200/ 110/ 210	5	2	4	4	2	Early Mature	Fair	Fair/ Poor It is growing out of the base of a shallow ditch. It divides at the base with an acute union formation between the stems. It has been drawn up for light with a distorted structure.	Retain for now as part of the bulking of this area.	10-20	C1
<b>The following trees are located to the east of a water filled ditch.</b>														
1803	<b>Ash</b> <i>Fraxinus excelsior</i>	13	280	3	4	5	0	2	Semi Mature	Fair	Fair/ Poor A single stem tree it is growing out of a wet ditch with a lean to the east. It divides at c. 2m into two stems with an acute union formation between the stems. It has a distorted structure.	Retain for now as part of the bulking of this area.	10+	C1
1804	<b>Ash</b> <i>Fraxinus excelsior</i>	12	240	2	3	5	3	4	Semi mature	Fair	Fair Most likely a self-sown tree growing out of a Hawthorn. It has been drawn out to the east for light. Light Ivy growth is developing up the main stem.	Retain for now as part of the bulking of this area.	10-20	C1
1805	<b>Oak</b> <i>Quercus robur</i>	16	850	6	7	8	5	3	Mature	Fair / Good	Fair A single stem tree growing on the east side of a water filled ditch. Heavy Ivy growth extends high into the crown increasing the crowns wind sail. The crown contains dead wood throughout. There is recent mechanical damage on the east side, to the lower branches.	Remove dead / unstable growth.  Cut Ivy at ground level.	20+	B1
1806	<b>Ash</b> <i>Fraxinus excelsior</i>	14	100/ 230/ 110	1	2	3	3	1	Semi Mature	Fair	Fair/ Poor A single stem tree with a distorted structure. It has been drawn up for light due to overcrowding and is growing out of the side of a water filled ditch.	Retain for now as part of the bulking of this area.	10+	C1



Tree No.	Tree Species	Ht. (m)	Stem Dia. (mm)	Branch Spread (m)				C-Ht. (m)	Age Class	Phys Con.	Structural Condition Other Comments	Preliminary Recommendation	Remain Contribute in years	Cat. Grade
				N	S	E	W							
											<b>N=North S=South E=East W= West</b> <b>Phys Con.</b> = Physiological Condition.	<b>A= Average</b> <b>C-Ht= Crown Height</b>		
											Minor stems at the base have recently been cut into the hedge height.			
1807	<b>Ash</b> <i>Fraxinus excelsior</i>	13	480/ 640	3	4	6	6	2	Early Mature	Fair	Fair / Poor A twin stem tree from the base growing at the east side of a water filled ditch. It has been cut down in the past into a pollard and has re-grown from the cut points. Recent works have caused mechanical damage / broken stems.	Retain for now as part of the bulking of this area.  Tidy up broken limbs/ branches	10-20	C1
1808	<b>Ash</b> <i>Fraxinus excelsior</i>	17	890	3	4	8	5	5	Mature	Fair	Fair A single stem tree growing out of the east side of a water filled ditch and it leans out to the east. Heavy Ivy growth extends high into the crown increasing the wind sail and limiting the visual assessment. It divides at c.4m into a multi-stem tree with an acute union formation between the stems.	Remove dead / unstable growth.  Cut Ivy at ground level.  Review again in twelve months.	10-20	C1
1809	<b>Ash</b> <i>Fraxinus excelsior</i>	12	650/ 530	4	3	7	5	3	Early Mature	Fair	Fair/Poor A single stem tree growing out of the east side of a water filled ditch. It divides at c.2.5m into two stems with an acute union formation between the stems. Heavy Ivy growth extends high into the crown. The crown has been left more open/ exposed by the cutting back of hedging and stems at the base. Minor stress/ decline evident and is most likely an indication of 'Ash Dieback'.	Remove dead / unstable growth and prune in heavy exposed side limbs/ branches to restore crown and address exposure.  Cut Ivy at ground level.  Review again in twelve months.	10-20	C1
1810	<b>Oak</b> <i>Quercus robur</i>	13	930	2	6	3	7	3	Mature	Fair	Fair A single stem tree growing out of the east side of	Remove dead / unstable growth.	20+	B1

Tree No.	Tree Species	Ht. (m)	Stem Dia. (mm)	Branch Spread (m)				C-Ht. (m)	Age Class	Phys Con.	Structural Condition Other Comments	Preliminary Recommendation	Remain Contribute in years	Cat. Grade
				N	S	E	W							
				N	S	E	W				<b>N=North S=South E=East W= West</b> <b>Phys Con.</b> = Physiological Condition.	<b>A= Average</b> <b>C-Ht= Crown Height</b>		
											a water filled ditch. Heavy Ivy growth extends high into the crown, increasing the wind sail and limiting the visual assessment. There are branch stubs on the east side at c.3m and there is recent mechanical damage to some of the lower branches. It has received past pruning to maintain clearance with overhead utility lines which has left the crown asymmetrical as a result.	Cut Ivy at ground level.		
1811	<b>Ash</b> <i>Fraxinus excelsior</i>	9	610	7	3	2	5	3	Mature	Fair	Fair / Poor Located on the east side of a water filled ditch. A single stem tree which has been topped in the past to clear the adjacent overhead power line, affecting its structure. It is re-growing from the cut points and will require further pruning in the future to maintain clearance. Ivy growth extends up the main stem.	Retain for now as part of the bulking of this hedge.  Cut Ivy at ground level.  It will require repeat pruning to maintain clearance with overhead utility lines.	10+	C1
1812	<b>Oak</b> <i>Quercus robur</i>	18	870	9	7	7	6	3	Mature	Fair / Good	Fair It is growing on the east side of a water filled ditch with a pronounced lean to the west before straightening up, it has an open/ exposed crown with some heavy side branches/ limbs. It is a single stem tree to c. 4m up, from where it divides into two co-dominant stems. There are signs of past storm damage in the lower crown which has left branch stubs.	Remove dead / unstable growth and prune in heavy exposed side branches by 1-2m.	20+	B1
<b>Hedge No. 2</b>	<b>Hawthorn</b> <i>Crataegus monogyna</i> <b>Blackthorn</b>	It extends on from the northern end of Hedge No. 1 on the far side of the field gap and it extends in a broadly northerly direction. It is of a mature age class in fair condition both physiologically and structurally. There is a deep, water filled, ditch located									Carry out further tidying works to improve structure and appearance.		C2	



Tree No.	Tree Species	Ht. (m)	Stem Dia. (mm)	Branch Spread (m)				C-Ht. (m)	Age Class	Phys Con.	Structural Condition Other Comments	Preliminary Recommendation	Remain Contribute in years	Cat. Grade
				N	S	E	W							
				N	S	E	W				N=North S=South E=East W= West Phys Con. = Physiological Condition.	A= Average C-Ht= Crown Height		
	<i>Prunus spinosa</i> <b>Ash</b> <i>Fraxinus excelsior</i> <b>Sycamore</b> <i>Acer pseudoplatanus</i> <b>Bramble</b> <i>Rubus fruticosus</i>	immediately to the west. It is mostly continuous along its length with a field gap located at the north end. Hawthorn and Blackthorn dominate with Bramble present along the line. It has recently been mechanically reduced to current height and spread.												
														
		A2.0		A1E, A1W		-								
		It contains the following trees.												
1813	<b>Sycamore</b> <i>Acer pseudoplatanus</i>	8	190/ 210	2	3	3	2	2	Semi Mature	Fair / Good	Fair It is growing slightly to the east of the main hedge line and has self-seeded into this location. A twin stem tree from the base with an acute union formation between the stems. The stems are growing in a co-dominant manner and light Ivy growth is extending up the main stems. Lower branches have recently been cut back, leaving stubs.	Prune branch stubs back to target pruning points.	20+	C1

Tree No.	Tree Species	Ht. (m)	Stem Dia. (mm)	Branch Spread (m)				C-Ht. (m)	Age Class	Phys Con.	Structural Condition Other Comments	Preliminary Recommendation	Remain Contribute in years	Cat. Grade
				N	S	E	W							
				N	S	E	W				N=North S=South E=East W= West Phys Con. = Physiological Condition.	A= Average C-Ht= Crown Height		
1814	<b>Ash</b> <i>Fraxinus excelsior</i>	11	890/ 440	5	6	5	6	3	Mature	Poor	Poor A single stem tree growing on the east side of a water filled ditch. It divides into two stems at c2m with a broad union formation. Heavy Ivy growth extends high into the crown increasing the wind sail. There is basal decay evident at the base which will impact upon its stability. The crown is showing signs of decline and is most likely due to 'Ash Dieback', it also contains deadwood throughout.	Remove dead / unstable growth. Cut/ coppice into the hedge line.  Monitor is condition	<10	U
1815	<b>Sycamore</b> <i>Acer pseudoplatanus</i>	13	640/ 270/ 190	7	4	6	6	1	Mature	Fair / Good	Fair It divides near the base into two stems with an acute union formation between the stems. The main stem divides again at c.3m into two co-dominant stems with further acute union formations. Lower branches have recently been damaged by mechanical activity leaving stubs. Heavy Ivy growth extends high into the crown increasing the wind sail.	Cut Ivy at ground level.	20+	B1
1816	<b>Sycamore</b> <i>Acer pseudoplatanus</i>	13	480/ 110	4	4	5	6	0	Mature	Fair	Fair A single stem tree growing on the east side of a water filled ditch. There are broken branches low on the main stem with branch stubs. Ivy growth extends up into the crown increasing the wind sail.	Cut Ivy at ground level.  Prune back stubs back to proper pruning points.	20+	B1
1817	<b>Ash</b> <i>Fraxinus excelsior</i>	13	720	7	5	4	5	6	Early Mature	Fair	Fair It divides at c.4m into two stems with a broad / acute union between the stems. The crown contains deadwood and there is mechanical	Cut Ivy at ground level.  Prune damaged branches back to target	10-20	C1



Tree No.	Tree Species	Ht. (m)	Stem Dia. (mm)	Branch Spread (m)				C-Ht. (m)	Age Class	Phys Con.	Structural Condition Other Comments	Preliminary Recommendation	Remain Contribute in years	Cat. Grade
				N	S	E	W							
										N=North S=South E=East W= West Phys Con. = Physiological Condition.	A= Average C-Ht= Crown Height			
										damage in lower branches which has left stubs. Ivy growth extends high into the crown increasing the wind sail.	pruning points.			
Hedge No. 3	<b>Hawthorn</b> <i>Crataegus monogyna</i> <b>Elder</b> <i>Sambucus nigra</i> <b>Ash</b> <i>Fraxinus excelsior</i> <b>Bramble</b> <i>Rubus fruticosus</i> <b>Goat Willow</b> <i>Salix caprea</i> <b>Blackthorn</b> <i>Prunus spinosa</i>	<p>It extends at ninety degrees from Hedge No. 1 in a broadly east to west direction across the site forming an internal boundary between fields.</p> <p>It is of a mature age class in fair condition physiologically and structurally. It is not continuous, with gaps along the line to allow passage between fields and also due to the overhead utility lines. It is located on the northern side of a derelict drainage ditch. It has recently been mechanically reduced to current height and spread. There is one mature Ash tree located along the line which extends above the general hedge height.</p>										<p>Carry out further general tidying works to improve appearance and structure.</p> <p>It would benefit from infill planting with hedgerow species.</p>	C2	
		A2.0		A2N, A2S				-						
														
		It contains the following tree.												

Tree No.	Tree Species	Ht. (m)	Stem Dia. (mm)	Branch Spread (m)				C-Ht. (m)	Age Class	Phys Con.	Structural Condition Other Comments	Preliminary Recommendation	Remain Contribute in years	Cat. Grade
				N	S	E	W							
											<b>N=North S=South E=East W= West</b> <b>Phys Con. = Physiological Condition.</b>	<b>A= Average</b> <b>C-Ht= Crown Height</b>		
1818	<b>Ash</b> <i>Fraxinus excelsior</i>	11	1180	5	5	4	3	2	Mature	Fair	Fair / Poor Growing above the general hedge line and is a single stem tree to c.3m where it divides into two co-dominant stems. It has been topped in the past to clear the adjacent overhead power line to the north east, affecting its structure. It is re-growing from the cut points and will require ongoing management to maintain clearance. Very heavy ivy growth extends high into the crown increasing the wind sail. There is recent mechanical damage to the base of the tree on the south east side.	Cut Ivy at ground level.  Cut broken stems back to proper target pruning points.  It will require further management to maintain clearance with the overhead utility lines.	10+	C1
Hedge No. 4	<b>Hawthorn</b> <i>Crataegus monogyna</i> <b>Elder</b> <i>Sambucus nigra</i> <b>Ash</b> <i>Fraxinus excelsior</i> <b>Sycamore</b> <i>Acer pseudoplatanus</i> <b>Oak</b> <i>Quercus robur</i> <b>Bramble</b> <i>Rubus fruticosus</i>	<b>It extends at ninety degrees from Hedge No. 1 in a broadly east to west direction along the boundary wall with 'Cappaghmore Estate'.</b> It is of a mature age class in fair condition physiologically and fair/ poor condition structurally. It is located along a soil bank on the southern side of a derelict drainage ditch. It consists of isolated clumps of Hawthorn and Elder with Bramble and coarse weeds developing along the line. It has been allowed to grow unmanaged for some time; however the encroachment of vegetation out into the site area has recently been cleared back. There is garden waste and dumped material at various locations along the top of the bank. It has some value for screening along this boundary.									Carry out general tidying works and make safe large dead/ unstable growth.  Cut back poorly structured hedge plants to address stability and structure.  It would benefit from infill planting of hedgerow species.  Remove waste.		C2	



Tree No.	Tree Species	Ht. (m)	Stem Dia. (mm)	Branch Spread (m)				C-Ht. (m)	Age Class	Phys Con.	Structural Condition Other Comments	Preliminary Recommendation	Remain Contribute in years	Cat. Grade
				N	S	E	W							
				N	S	E	W				N=North S=South E=East W= West Phys Con. = Physiological Condition.	A= Average C-Ht= Crown Height		
														
		A3.0		A2N, A2S				-						
		It contains the following trees.												
1819	<b>Ash</b> <i>Fraxinus excelsior</i>	19	1100	8	9	10	7	6	Mature	Fair	Fair A large, prominent single stem tree to c.6m where it divides into a multi-stem tree with a broad spreading crown. Heavy Ivy growth on the low and mid crown areas has limited the visual assessment. There is a dead Elm tree at the base.	Remove dead/ unstable growth and prune in heavy end loaded side limbs/ branches by 1-2m  Cut Ivy at ground level.	10-20	C2

Tree No.	Tree Species	Ht. (m)	Stem Dia. (mm)	Branch Spread (m)				C-Ht. (m)	Age Class	Phys Con.	Structural Condition Other Comments	Preliminary Recommendation	Remain Contribute in years	Cat. Grade
				N	S	E	W							
											<b>N=North S=South E=East W= West</b> <b>Phys Con.</b> = Physiological Condition.	<b>A= Average</b> <b>C-Ht=</b> Crown Height		
											It contains some heavy side limbs/ branches and some of these extend in over the adjoining property to the south. Its crown has been left more open/ exposed on the east side by the loss of the neighbouring tree.	Remove dead Elm tree at the base.  Review again in twelve months.		
1820	<b>Ash</b> <i>Fraxinus excelsior</i>	20	980	7	7	6	5	5	Mature	Fair	Fair A large prominent single stem tree, it divides at c.7m from where the crown develops. Light Ivy growth is developing on the main stem. Some basal decay is evident and the crown is showing some early signs of decline, this may be due to infection with 'Ash Dieback'.	Remove dead/ unstable growth and lighten in heavy side limbs/ branches by 1-2m.  Review again in twelve months.	10-20	C2
1821	<b>Sycamore</b> <i>Acer pseudoplatanus</i>	19	470/ 520/ 610	7	5	6	8	2	Mature	Fair	Fair A large, multi-stem tree from the base with a distorted structure. There are acute union formations between the two stems at the base. The stem on the west side has broken out in the past at c.1.8m leaving a decay pocket to develop. There are decay pockets developing in the crown at the sites of past branch loss / removal.	Remove dead/ unstable growth and reduce end weight on heavy side limbs/ branches by 1-2m.	20+	B2
1822	<b>Ash</b> <i>Fraxinus excelsior</i>	6	330	2	2	6	0	0	Early Mature	Poor	Poor A single stem tree growing with a pronounced lean and a distorted structure. It has broken out at c.5m and has collapsed along the line. It has no potential.	Remove broken stem.	<10	U
1823	<b>Oak</b> <i>Quercus robur</i>	22	1300	10	9	6	5	3	Mature	Fair / Good	Fair A large prominent tree, with an asymmetric crown weighed out to the east due to competition from	Remove dead / unstable growth and carry out pruning to shape/	20+	B2



Tree No.	Tree Species	Ht. (m)	Stem Dia. (mm)	Branch Spread (m)				C-Ht. (m)	Age Class	Phys Con.	Structural Condition Other Comments	Preliminary Recommendation	Remain Contribute in years	Cat. Grade
				N	S	E	W							
											<p><b>N</b>=North <b>S</b>=South <b>E</b>=East <b>W</b>= West  <b>Phys Con.</b> = Physiological Condition.</p>			
											<p>adjoining trees. Heavy Ivy growth extends high into the crown increasing the wind sail and limiting the visual assessment.</p>	<p>A= Average  <b>C-Ht</b>= Crown Height            balance the crown.            Cut Ivy at ground level.            Review again in twelve months.</p>		
1824	<b>Ash</b> <i>Fraxinus excelsior</i>	20	750	10	6	6	4	5	Mature	Fair	<p>Fair            A single stem tree with a distorted structure, it has been drawn out to the east for light due to overcrowding/ competition. Heavy Ivy growth extends high into the crown increasing the wind sail. There is minor dead wood throughout.</p>	<p>Remove dead / unstable growth and lighten in heavy exposed side limbs/ branches by 1-2m.            Cut Ivy at ground level.</p>	10-20	C1
1825	<b>Oak</b> <i>Quercus robur</i>	19	1100	9	7	7	8	6	Mature	Fair	<p>Fair            A large prominent tree, which divides at c.6m into a multi-stem tree. A large scaffold limb, extending to the north from c.3m, has suffered damage to the ends leaving stubs. The crown contains branch stubs with deadwood throughout; it has also suffered from storm damage in the crown.</p>	<p>Remove dead / unstable growth.            Reduce end loading on branches by 1-2m</p>	20+	B2
1826	<b>Sycamore</b> <i>Acer pseudoplatanus</i>	15	400/ 250/ 110	6	5	4	6	1	Early Mature	Fair	<p>Fair            A single stem tree drawn up and out to the north for light affecting the structure. It is somewhat suppressed by the surrounding trees. Heavy Ivy growth extends high into the crown increasing the wind sail.</p>	<p>Cut Ivy at ground level.</p>	10-20	C2
1827	<b>Ash</b> <i>Fraxinus excelsior</i>	13	320	1	6	3	4	5	Mature	Fair	<p>Fair/ Poor</p>	<p>Retain for now as part of</p>	10+	C2

Tree No.	Tree Species	Ht. (m)	Stem Dia. (mm)	Branch Spread (m)				C-Ht. (m)	Age Class	Phys Con.	Structural Condition Other Comments	Preliminary Recommendation	Remain Contribute in years	Cat. Grade
				N	S	E	W							
											<b>N=North S=South E=East W= West</b> <b>Phys Con.</b> = Physiological Condition.	<b>A= Average</b> <b>C-Ht= Crown Height</b>		
											A single stem tree, it has been drawn up and out to the south for light affecting its structure. The crown is somewhat suppressed by surrounding trees while decay at the base may impact upon its stability.	the bulking of this area and monitor its condition.		
1828 & 1829	<b>Ash</b> <i>Fraxinus excelsior</i>	A14	A210 / 150	A7	A4	A3	A2	A2	Early Mature	Fair/ Poor	Fair/ Poor A pair of trees growing up together with a combined canopy. They have been drawn up for light affecting their structure. Their crowns contain minor deadwood throughout. Their crowns are also showing some signs of decline which is most likely evidence of infection by 'Ash Dieback'.	Retain for now as part of the bulking of this area and monitor their condition.	10+	C2
1830	<b>Ash</b> <i>Fraxinus excelsior</i>	13	150/ 220/ 180	3	5	5	3	1	Early Mature	Fair/ Poor	Fair / Poor A multiple stemmed tree from the base, it has been drawn up for light affecting its structure. Ivy growth extends high up into the crown increasing the wind sail. There is some stress/ decline evident within its crown.	Cut Ivy at ground level.  Retain for now as part of the bulking of this area and monitor its condition.	10+	C2
1831	<b>Ash</b> <i>Fraxinus excelsior</i>	12	410/ 390	7	6	4	4	3	Early Mature	Fair	Poor A multiple-stemmed tree from the base, growing up with a combined canopy. Ivy growth extends high into the crowns increasing the wind sail. There is an area of dead bark at the base with some stress/ decline evident in the crown.	Cut Ivy at ground level.  Retain for now as part of the bulking of this area and monitor its condition.	10+	C2
1832	<b>Ash</b> <i>Fraxinus excelsior</i>	14	220/ 200	5	6	5	4	2	Early Mature	Fair	Fair Multiple-stemmed from base and are growing up together in a co-dominant manner. Ivy growth extends high into the crowns increasing the wind sail.	Cut Ivy at ground level.  Retain for now as part of the bulking of this area.	10-20	C2



Tree No.	Tree Species	Ht. (m)	Stem Dia. (mm)	Branch Spread (m)				C-Ht. (m)	Age Class	Phys Con.	Structural Condition Other Comments	Preliminary Recommendation	Remain Contribute in years	Cat. Grade
				N	S	E	W							
				N	S	E	W				<b>N=North S=South E=East W= West</b> <b>Phys Con.</b> = Physiological Condition.	<b>A= Average</b> <b>C-Ht= Crown Height</b>		
1833	<b>Ash</b> <i>Fraxinus excelsior</i>	15	450/ 390	6	5	4	5	3	Early Mature	Fair/ Poor	Fair/ Poor Multiple stemmed from the base, growing up together in a co-dominant manner. Ivy growth extends high into the crowns increasing the wind sail. Some stems are also showing some signs of stress/ decline, most likely due to an infection by 'Ash Dieback'.	Cut Ivy at ground level.  Retain for now as part of the bulking of this area and monitor its condition.	10+	C2
1834	<b>Ash</b> <i>Fraxinus excelsior</i>	12	220/ 160/ 90	6	5	5	2	2	Early Mature	Fair/ Poor	Fair / Poor A single stem tree which has been drawn up and out for light distorting its structure. The crown is being suppressed by surrounding trees.	Retain for now as part of the bulking of this area.	10+	C2
1835	<b>Oak</b> <i>Quercus robur</i>	22	790	11	5	8	7	8	Mature	Fair/ Good	Fair A large, single stem tree to c.8m from where the crown develops. There is a broken branch hanging on the north side at c.7m Heavy Ivy growth has been controlled.	Remove dead / unstable growth.	20+	B2
1836	<b>Ash</b> <i>Fraxinus excelsior</i>	11	580	2	5	2	3	6	Mature	Fair/ Poor	Poor A single stem tree with a distorted structure due to past overcrowding. It has an asymmetrical crown, weighted towards the garden to the south. The crown is showing some signs of stress/ decline, most likely due to an infection by 'Ash Dieback'. Ivy growth has been controlled. It has no potential.	I would recommend its <b>removal</b> as part of management.	<10	U
<b>Hedge No. 5</b>	<b>Hawthorn</b> <i>Crataegus monogyna</i> <b>Elder</b> <i>Sambucus nigra</i> <b>Oak</b> <i>Quercus robur</i>	It extends in a broadly north to south direction along the back boundary wall with 'Cappaghmore Estate'. It is growing on the east side of a deep water filled ditch.									It would benefit from cutting and tidying to thicken up and improve structure.		C2	

Tree No.	Tree Species	Ht. (m)	Stem Dia. (mm)	Branch Spread (m)				C-Ht. (m)	Age Class	Phys Con.	Structural Condition Other Comments	Preliminary Recommendation	Remain Contribute in years	Cat. Grade
				N	S	E	W							
				N	S	E	W				N=North S=South E=East W= West Phys Con. = Physiological Condition.	A= Average C-Ht= Crown Height		
	Ash <i>Fraxinus excelsior</i>  Bramble <i>Rubus fruticosus</i>													
				It is of a mature age class in fair condition both physiologically and structurally. There is a deep, water filled, ditch located immediately to the west of this hedge, which prevents access from the site side. It is mostly continuous along its length and has been allowed to grow unmanaged for some time. It forms part of a longer hedge line and contains a number larger trees along its length. It consists mainly of clumps of Hawthorn and Elder with Bramble colonizing.										
				A4.0			A2E, A2W		-					
				<b>It contains the following trees.</b>										
1837	Oak <i>Quercus robur</i>	15	580	2	5	2	3	6	Mature	Fair	Fair A single stem tree to c.6m from where it divides into two co-dominant stems with an acute union formation between the stems. Heavy Ivy growth extends high into the crown increasing the wind sail. The crown size has been reduced in the past and it has developed a new crown from these old pruning points.	Cut Ivy at ground level.  Review again in twelve months	10+	C2



Tree No.	Tree Species	Ht. (m)	Stem Dia. (mm)	Branch Spread (m)				C-Ht. (m)	Age Class	Phys Con.	Structural Condition Other Comments	Preliminary Recommendation	Remain Contribute in years	Cat. Grade
				N	S	E	W							
											<b>N=North S=South E=East W= West</b> <b>Phys Con.</b> = Physiological Condition.	<b>A= Average</b> <b>C-Ht= Crown Height</b>		
Tree No. 1	<b>Ash</b> <i>Fraxinus excelsior</i>	15	500	5	4	5	4	6	Mature	Fair	Fair Originally a larger tree, it has been topped in the past to c.8m affecting its structure. It has re-grown from the cut points to the current height. It divides into two co-dominant stems with an acute union formation between the stems. Heavy Ivy growth has been controlled	Review again in twelve months.	10-20	C2
Tree No. 2	<b>Oak</b> <i>Quercus robur</i>	16	750	7	5	6	6	4	Early Mature	Fair	Fair It has been drawn up and out for light affecting its structure. It extends out from the face of the ditch before turning vertical. There are signs of past branch removal in the lower crown on the west side. There are also signs of past storm damage in the crown.	Remove dead / unstable growth.	10-20	C2
Tree No. 3	<b>Oak</b> <i>Quercus robur</i>	17	700/ 500	5	5	4	6	4	Mature	Good	Fair A large, single stem tree with heavy Ivy growth extending high into its crown, increasing the wind sail and limiting the visual assessment. It divides at c.2.5m into two co-dominant stems with an acute union formation.	Cut Ivy at ground level.  Review again in twelve months.	20+	B2
Tree No. 4	<b>Oak</b> <i>Quercus robur</i>	15	900	6	5	5	7	2	Mature	Good	Fair A large, single stem tree growing with a lean to the north. Heavy Ivy growth extends high into the crown, increasing the wind sail and limiting the visual assessment.	Cut Ivy at ground level.  Review again in twelve months.	20+	B2
<b>Notes:</b>														

Tree No.	Tree Species	Ht. (m)	Stem Dia. (mm)	Branch Spread (m)				C-Ht. (m)	Age Class	Phys Con.	Structural Condition Other Comments	Preliminary Recommendation	Remain Contribute in years	Cat. Grade
				N	S	E	W							
				N	S	E	W				N=North S=South E=East W= West Phys Con. = Physiological Condition.	A= Average C-Ht= Crown Height		





