

RED

Equinix DB08 Data Centre, Ireland External Lighting Design Report

Profile Business Park

South Dublin County Council



Client Equinix
Joule House,
Trafford Park,
Manchester M17 1HE

Date 23 May 2022
File Ref DB080-RED-ZZ-Z-RP-E-LITE-0001
Revision P2

Classification Public | Internal | Restricted | Confidential

A company of  **ENGIE**
Impact



Revision

REVISION	REVISION DETAILS / ISSUE TYPE	PAGE NOS	DOCUMENT PREPARED BY			DOCUMENT CHECKED BY		
			NAME	SIGNATURE	DATE	NAME	SIGNATURE	DATE
P0	New Document / Draft	All	CT (RED)		20/6/2021			
P1	New Document / Final	All	CT (RED)		24/6/2021			
P2	Planning Submission	All	JM		23/06/2022			

This document and its contents are confidential and have been prepared and are intended solely for Equinix's information and use in relation to DB080.

Red Engineering Design Limited accepts no responsibility or liability to any other party (exception for death and personal injury) in respect of or arising out of or in connection with this document and/or its contents.

Copyright:

The copyright of this document is vested in Red Engineering Design Limited. This document may not be reproduced in whole or in part without their express written permission.



Contents

1.0	INTRODUCTION	1
1.1	Project	1
1.2	Purpose of Report	1
1.3	Application Site Location and Context	2
1.4	Definitions	3
1.5	General Lighting	4
2.0	DESIGN GUIDES & INDUSTRY STANDARDS	5
3.0	METHODOLOGY	6
3.1	Desk based Information	6
3.2	Sensitive Receptors	6
3.3	ILP Environmental Zone Classification	6
3.4	Road Lighting	7
4.0	LIGHTING ASSESSMENT	9
4.1	Ecological Receptors (Protection of Nocturnal Species)	10
4.2	Best Practice Design	11
5.0	MITIGATION MEASURES	12
6.0	CONCLUSIONS	13
7.0	APPENDIX A	15



1.0 Introduction

1.1 Project

RED Engineering Design has been appointed by Equinix to carry out a desk-based external lighting study in support of a planning application for a proposed Data Centre facility development at Profile Business Park, South Dublin County Council.

1.2 Purpose of Report

This report outlines the design approach for the new external lighting scheme for the proposed development of a Data Centre Facility on land at Profile Business Park, with the specific intention of expressing methods for the reduction of obtrusive light.

The proposal is to ensure the future external lighting scheme is as unobtrusive as possible, complies with guidelines for the reduction of light pollution and to satisfy the local planners and the local community.

The external lighting scheme will be designed to create a safe external environment by providing artificial lighting in the hours of darkness, whilst ensuring the lighting is obtrusive to the environment and neighbouring properties. Also of vital importance is the visual impact perspective upon the biodiversity protection zone (ecological zone of influence). This report focuses on the external lighting required for the development and satisfying the strict lighting parameters necessary for the area and ecology.

A desktop study utilising professionally recognised computer generated lighting calculation, DIALux software, has assessed the proposed lighting systems conformity with recognised guideline requirements.

This external lighting report is to be read in conjunction with the following drawings submitted with this application that have been prepared to demonstrate the external lighting design.

- DB080-RED-ZZ-0G-DR-E-LITE-1020 Exterior lighting layout – Phase 1 Proposed Site Layout
- DB080-RED-ZZ-0G-DR-E-LITE-1021 Exterior lighting layout – Phase 1 Lighting Levels
- DB080-RED-ZZ-0G-DR-E-LITE-1022 Exterior lighting layout – Phase 1 Proposed Lighting Scheme
- DB080-RED-ZZ-0G-DR-E-LITE-1023 Exterior lighting layout – Phase 1 Isolines
- DB080-RED-ZZ-0G-DR-E-LITE-1024 Exterior lighting layout – Phase 1 Spill Light
- DB080-RED-ZZ-0G-DR-E-LITE-1020 Exterior lighting layout – Phase 1 Visual Presentation of Proposed Model
- DB080-RED-ZZ-0G-DR-E-LITE-1020 Exterior lighting layout – Phase 1 Visual Presentation of Proposed Model

The External lighting design and analysis of the lighting model for this Application Site demonstrates, to the best of our ability, compliance where possible with the guidance notes and design standards as noted within.

1.3 Application Site Location and Context

The Development will consist of:

- Modifications to the permitted data centre granted under SDCC Reg. Ref. SD21A/0186 comprising the following:
 - Reconfiguration and alterations to the data centre building to include removal of front of house offices at third floor level, alterations to floor levels at second floor to provide consistency between front of house and data halls, parapet height increase of front of house to c.16.8m, provision of storage at second floor level in lieu of relocated internal generators to the external generator yard and associated elevational alterations.
 - Extension of loading dock at ground floor level by c.60sqm in area with minor height increase to c.5.3m .
 - Removal of 3 no. air plenums to the front (north) elevation and provision of screening to generator flues in lieu of omitted plenums.
 - Alterations at roof level to include removal of 2m high gantry screening.
 - Alterations to the permitted generator plant yard to the north of the data centre to include the removal of fuel tanks, reconfiguration of plant and generators, provision of 2 no. additional external generators (increase from 5 to 9 no. external generators), provision of 4 no. additional external plant rooms, provision of diesel pump tank cabinets and stepover, relocation of generator yard doors and enlarged generator yard to accommodate the proposed modifications.
 - Reconfiguration of plant within the permitted chiller plant yard to the south of the data centre.
 - Removal of 1 no. sprinkler/water tank and removal of stairs and door to the side of the waste compound.
 - Reconfiguration of car parking and motorcycle spaces and removal of 1 no. accessible space. 64 no. total number of car parking spaces.
- The proposal also includes provision of on-site gas power generation compound (c.2,604sqm in area) in the area previously reserved for a future data centre. The compound comprises 7 no. modular plant rooms (totalling c.180sqm in area), 10 no. gas fired generators and associated flues c.14.7m high, gas skid, associated modular plant, boundary treatment surrounding the compound c.6.5m high and 2 no. vehicular access points including general and emergency access.
- All associated site development works, services provision, drainage works, access, landscaping and boundary treatment works.
- No buildings are proposed above the existing ESB and SDCC wayleaves to the west and north of the site.
- Overall Gross Floor Area of the development is reduced by c. 445sqm to c.9,795sqm from previously permitted under SDCC Reg.Ref. SD21A/0186
- The application is accompanied by a Natura Impact Statement.

Figure 1: Proposed site location and boundary outline (Source: Google Maps 2021)



1.4 Definitions

Lux (lx) is the unit in which light is measured on a surface from a source. Unit used to define illumination. 1 lux is equal to 1 lumen falling on an area of 1 square meter.

Average Lux (Eav) is the maintained average illuminance.

Minimum Lux (Emin) is the maintained minimum illuminance.

Maximum Lux (Emax) is the maintained maximum illuminance.

Upward Light Ratio (ULR) is the maximum permitted percentage of luminaire flux that goes directly into the sky.

Sky Glow is the illumination of the night sky caused by artificial light.

Obtrusive light is the existing spilling of light beyond the boundary of the area being lit.

Spill light – For the purpose of this report spill light can be defined as the illumination that is produced by a light source or light sources at a point or surface on which the light is not intended or desirable.

Glare – The discomfort or impairment of vision experienced when the image is excessively bright compared to the general surroundings.

Environmental Zones are a permitted classification for the environment in which lighting can be designed to recommended levels.

1.5 General Lighting

The following table is intended to provide points of reference. The data represents a conservative example of the lux measurements for the given conditions found worldwide:

Table 1: General Lux Levels

Light Source	Horizontal Lux
Full Moon to Twilight	0.1 to 10
Typical City Centre Car Park	20 to 40
Street Lights – Housing Estate	2.5 to 10
Street Lights – Residential Estate	1 to 6
Office/Classroom	400 to 750
Professional Stadium	2,000 to 3,500
Sunny Day	30,000 to 50,000

2.0 Design Guides & Industry Standards

The proposed external lighting scheme has been designed in accordance with good practice guidance documents and National & International Industry Standards, incorporating the following:

- IS EN 12464-2: Lighting of Work Places - Outdoor Work Places
- IS EN 13201-2: Road Lighting - Performance Requirements
- BS 5489-1: Code of Practice for the Design of Outdoor Lighting - Lighting of Roads and Public Amenity Areas
- IS 10101: National Rules for Electrical Installations
- Institute of Lighting Professionals (ILP)– Guidance Notes for the Reduction of Obtrusive Light
- CIBSE/Society of Light and Lighting (SLL) – Lighting Guide 6 (LG6) – The Outdoor Environment
- CIBSE/Society of Light and Lighting (SLL) – Lighting Factfile 7 (LF07) – Design and Assessment of Exterior Lighting Schemes
- CIBSE/Society of Light and Lighting (SLL) – Lighting Handbook
- Institute of Lighting Professionals and the Bat Conservation Trust – Bats and Lighting in the UK
- CIE 126 Guidelines for Minimising Sky Glow
- CIE 150 Guide on the Limitation of the Effects of Obtrusive Light from Outdoor Lighting Installations

The ILP's 'Guidance Notes for the Reduction of Obtrusive Light' provides the basis for the comparative analysis when defining whether an installation will be obtrusive to the environment and neighbouring properties. It assists in quantifying and providing acceptable maximum threshold recommendations for light spill, sky glow and glare. Good lighting design also includes luminaires that have been selected to minimise light intrusion and glare to pedestrians and drivers. This is the primary document used by most local councils and planning departments to categorise the provision of external lighting, in accordance with best practice.

3.0 Methodology

3.1 Desk based Information

A desktop review of the Application Site and surrounding area has been undertaken to identify potential light sensitive receptors and to establish the appropriate Environmental Zone classification for the Application Site as defined by the ILP's Guidance Notes for Obtrusive Light.

Light modelling was undertaken using DIALux software, an independent lighting model which is capable of calculating daylight and artificial lighting scenes in interior and exterior scenarios. The model incorporates ILP and IS EN 12464-2 calculation methodologies and is commonly used for lighting impact assessment.

3.2 Sensitive Receptors

Sensitive receptors within and immediately around the Application Site have been identified taking into account the recommendations in ILP's Guidance Notes for Obtrusive Light and drawing on the following technical assessments submitted with the planning application:

- Natura Impact Statement for proposed development (Equinix DB8) by Malone O'Regan Environmental, June 2021.
- Ecological Impact Assessment for proposed development (Equinix DB8) by Malone O'Regan Environmental, June 2021.

3.3 ILP Environmental Zone Classification

The ILP has established Environmental Zones for exterior lighting based on the existing external ambient lighting levels in the area (see Table 2). The guidance note classifies environmental zones into five categories.

The ILP Environmental Zone classification for the Application Site and its surroundings has been determined based on professional judgement but is subject to consultation and agreement with the local planning authority.

Predictive modelling has been undertaken to study, identify and reduce potential light pollution from the Application Site to achieve compliance with ILP Guidance notes for the Reduction of Obtrusive Light / IS EN 12464-2 Table 2, for **Environmental Zone E3**.

Table 2: Environmental Zone Classifications (Source: ILP GN01/21, Table2)

Zone	Surrounding	Lighting environment	Examples
E0	Protected	Dark (SQM 20.5+)	Astronomical Observable dark skies, UNESCO starlight reserves, IDA dark sky places
E1	Natural	Dark (SQM 20 to 20.5)	Relatively uninhabited rural areas, National Parks, Areas of Outstanding Natural Beauty, IDA buffer zones etc.
E2	Rural	Low district brightness (SQM ~15 to 20)	Sparsely inhabited rural areas, village or relatively dark outer suburban locations
E3	Suburban	Medium district brightness	Well inhabited rural and urban settlements, small town centres of suburban locations
E4	Urban	High district brightness	Town / City centres with high levels of night-time activity

A category Environmental Zone E3 is defined in IS EN 12464-2 Clause 4.5 (Table 2) as 'medium district brightness areas, such as industrial or residential suburbs' and in ILP Guidance note GN01/21 as 'medium district brightness areas such as well in habited rural and urban settlements, small town centres of suburban locations'. This site would comply with both the definitions provided for a category E3 scheme.

The ILP Environmental Zone classification determines the appropriate exterior lighting limitations for that area. The specification of the limitations for each ILP Environmental Zone are set out in the below tables extracted from ILP Guidance note GN01/21.

Table 3: Maximum values of vertical illuminance on premises and management of spill light (Source: ILP GN01/21, Table 3)

Light technical parameter	Application conditions	Environmental zone				
		E0	E1	E2	E3	E4
Illuminance in the vertical plane (E _v)	Pre-curfew	n/a	2 lx	5 lx	10 lx	25 lx
	Post-curfew	n/a	<0.1 lx*	1 lx	2 lx	5 lx

Table 4: Maximum values of upward light ratio (ULR) of luminaires [Limitation of Skyglow] (Source: ILP GN01/21, Table 6)

Light technical parameter	Environmental zones				
	E0	E1	E2	E3	E4
Upward light ratio (ULR) / %	0	0	2.5	5	15

Please note that the External lighting design has not taken into account the assessment of intensity at the observer approach as per Table 4 of ILP GN01/21.

In accordance with Environmental Zone classification E3, medium district guidance, is to have a maximum sky glow (URL) limit of 5%, maximum light trespass of between 10 to 2 lux (pre and post curfew). As the proposed Site Application is for a Data Centre that will operate 24/7, the 'pre-curfew' values noted in ILP Guidance notes for the Reduction of Obtrusive Light Table 3, have been ignored. The more onerous 'post-curfew' value of 2 Lux is to be applied to the design methodology (maximum trespass / spill lighting).

3.4 Road Lighting

The class of site roadway lighting design intended for pedestrians and pedal cyclists on footways, cycleways, emergency lanes and other road areas lying separately or along the carriageway of a traffic route, and for residential roads, pedestrian streets, parking places, schoolyards etc is based on P class 'P1' requirements as stipulated in IS EN 13201-2.

The minimum maintained average illuminance will be designed to achieve 15 lux.

Table 5: P Lighting classes for pedestrian and pedal cyclists (Source: IS EN 13201-2, Table 3)

Class	Horizontal illuminance		Additional requirement if facial recognition is necessary	
	E^* [minimum maintained] lx	E_{min} [maintained] lx	$E_{v,min}$ [maintained] lx	$E_{sc,min}$ [maintained] lx
P1	15,0	3,00	5,0	5,0
P2	10,0	2,00	3,0	2,0
P3	7,50	1,50	2,5	1,5
P4	5,00	1,00	1,5	1,0
P5	3,00	0,60	1,0	0,6
P6	2,00	0,40	0,6	0,2
P7	performance not determined	performance not determined		

^a To provide for uniformity, the actual value of the maintained average illuminance shall not exceed 1,5 times the minimum E value indicated for the class.

4.0 Lighting Assessment

Light pollution is a recognised statutory nuisance. Obtrusive light from floodlighting within the Application Site boundary on to adjacent roads and surrounding biodiversity protection ecological zone shall be minimised by taking into consideration (a) Sky glow (b) Light trespass, over illumination and (c) Glare.

The qualitative assessment considers:

- The change in views as a result of the introduction of external lighting at night-time; and
- The effects of obtrusive light on sensitive receptors such as the biodiversity protection zone (ecological zone of influence). This includes against any potential impacts on nocturnal species in line with the Bat Conservation Trust (BCT) guidelines.

The following three components of artificial light in open spaces contribute to the potential for obtrusive light as shown in Figure 2:

Sky glow – this is the general illumination of the night sky above conurbations and any areas where there are large amounts of artificial light. It comprises aspects of reflected light from illuminated surfaces, direct upward light from lighting installations and intrusion light, which is light which falls outside the specific area to be lit.

Light Intrusion (or ‘trespass’) – this is light which affects areas beyond those which are supposed to be lit by a particular source and which, depending on the nature of the receptor affected, has the potential to cause nuisance and disturbance.

Glare – this is the brightness of a light source when viewed against a dark background. Most often experienced when the light source itself (i.e. the bulb or tube) is directly visible and is not covered by a shield, cowl or directed by a suitable lens/reflector arrangement.

Figure 2: Types of Obtrusive light (Source: ILP Guidance Note GN01/21)

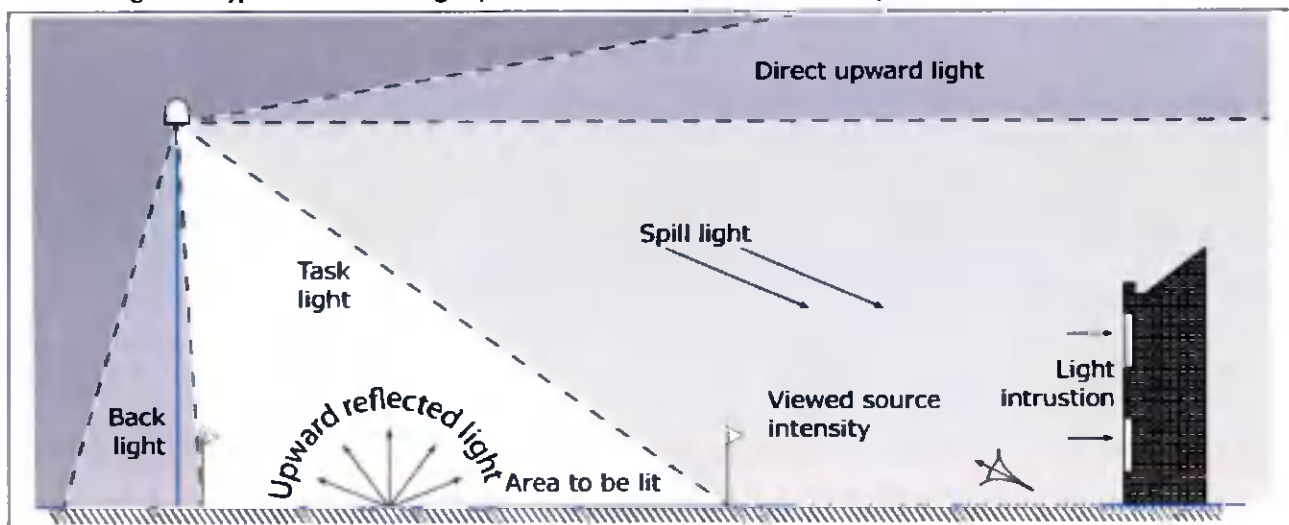

A lighting model was developed to represent the proposed external lighting scheme and to enable the obtrusive light to be calculated & evaluated. Lighting level requirements within the Application Site were designed to ensure sufficient illumination to carry out relevant tasks safely and allow safe access and egress for employees.

The design of the lighting has been undertaken in a manner such as to address two potentially conflicting needs; namely, on the one hand, to provide a safe environment for the movement of pedestrians, vehicles, motorcycles, bicycles & HGVs when the natural lighting levels fall and, on the other hand, to meet the light obtrusion limitations stated within the relevant standards and guidance in order to avoid any detriment to local amenity and wildlife in the adjacent biodiversity protection zone (ecological zone of influence).

The proposed development will require the installation of a number of luminaires that have the potential to increase lighting levels at ecological receptors within the biodiversity protection zone.

The following stages have therefore been undertaken in order to produce a suitable external lighting design for the purposes of this assessment and assess potential impacts:

- Qualitative assessment of potential lighting impacts at light-sensitive receptors bordering the proposed development site, based on the proposed external lighting design and;
- Formulation of appropriate mitigation measures, where necessary, in order to minimise the potentially detrimental impacts of the lighting scheme.

The use of high efficiency, low energy LED lighting is one of the key elements to assist with South Dublin County Council Development plan, 'Energy Performance in New Buildings'.

Lighting shall be mounted on buildings where possible or alternatively on low level lighting columns (posts) and bollards. Secondary access and egress lights for maintenance will be controlled separately and only used when required or under emergency conditions.

The model has been used to calculate the predicted Upward Lighting Ratio (ULR) of the proposed external lighting scheme. The ULR of luminaires would be assessed to ensure the ratio of light emitted at and above the horizontal to the total light emitted is within the guidelines in the environmental zones classification. The proposed scheme is to have a ULR value of 0% (no upward light / sky glow). This falls within the recommended 5% for an E3 zone, 2.5% for an E2 Zone as well as 0% for E1. Model outputs predict a sky glow figure (ULR) of 0% and is therefore not considered to result in impacts on the dark sky landscape.

The external lighting scheme of the Application Site is illustrated on the referenced drawings. Lighting design calculations have been provided for reference purposes in Appendix A.

4.1 Ecological Receptors (Protection of Nocturnal Species)

Nocturnal mammals are impacted by lighting. While some bat species, are more tolerant with light levels above the Environmental zone E3 post curfew criteria, it reflects worst-case assumptions concerning the sensitivity of those species present to background illuminance levels. It is believed that most bat emergence requires light levels below 1 lux for late emerging species, up to 14 lux for those that emerge earlier. These lighting levels of 1 lux are required to ensure that bat commuting, and foraging routes are not impacted and that dark corridors beyond the limits of the site are retained. As such, the assessment criteria represents a worst-case scenario in terms of impacts on emergence, commuting and foraging (Bat Conservation Trust).

When determining the likely impacts of lighting associated with the proposed development on sensitive ecological receptors, the assessment has considered the effect of lighting pre-mitigation. Impacts are considered potentially significant where predicted illuminance exceeds 1 lux at ecological receptors. If this is the case, further consideration will be given to mitigation measures.

4.2 Best Practice Design

As well as meeting the statutory design standards outlined in the above section, the external lighting design has sought to meet a number of criteria to ensure that the environmental effects of artificial lighting are managed to a high standard. These criteria are:

- All luminaires will be mounted at 0° tilt to minimise upward light
- The area will be lit in accordance with the minimum requirements set-out in IS EN 12464-2
- Light intrusion has been reduced as far as possible into the surrounding areas
- Efficient LED light sources have been selected throughout to minimise energy consumption
- All new column-mounted luminaires shall be fitted with flat glass to aid 0% upward light discharge
- The column mounted lighting luminaires mounting height is not to exceed 5m

Potential glare and over illumination concerns have been evaluated to ensure that the design proposal includes for high quality optics coupled with aiming to mitigate against light spill and sky glow as part of the design process.

Please note that illumination of spill calculations do not take into consideration architectural landscaping proposals which are intended to provide visual screening between adjacent properties and areas of illumination. Such landscaping screening (trees, berms, fences and the like) would further reduce light trespass.

5.0 Mitigation Measures

The following mitigation measures shall be implemented to ensure that adverse impacts of lighting associated with the proposed Application site are minimised. These include;

Using appropriately designed luminaires for the task at hand. The light fittings proposed for the scheme have been chosen due to their high optical efficiency. The luminaires shall be provided with accessories, for on-site 'fine tuning', in areas of extreme sensitivity.

A selection of quality lenses that allow flexibility in use specific to the task being performed have been used for the column lighting eg asymmetric medium wide & wide light, symmetric wide light, extremely asymmetric light distribution to left or right for pedestrian crossings as well as possible rotation of the lenses in 90 degree steps. This allows the fitting to provide a much more controlled spread of light, reducing spill and glare and flexibility for site adjustment.

Additional reduction of light emission to the rear of the LED via a shielding lens system to the roadway LED column lighting shall be implemented in order to further limit light spill (cut-off) to the biodiversity protection zone (ecological zone of influence).

Should glare prove to be an issue from a particular viewpoint, the luminaires consist of a tilt facility that can assist local adjustments.

The external lighting controls shall consist of photocell and time clock arrangements. Passive infrared sensors (PIR) and/or dimming profiles will also be considered e.g. luminaires could either be dimmed or every second luminaire switched off past a designated curfew time.

Reducing lighting levels outside working hours to suitable levels for safety and security in compliance with the obtrusive light limitations for Environmental Zone E3.

6.0 Conclusions

The external light fixtures proposed for the scheme are of the energy-efficient LED type that have been chosen due to their high optical efficiency.

In accordance with Environmental Zone classification E3, the maximum sky glow / upward light ratio (URL) limit of 5% has not been exceeded. The lighting calculation demonstrates that the proposed external lighting scheme achieves 0%. This indicates that no upward lighting / sky glow will occur as all light fixtures have been modelled to be mounted at 0 degrees.

The maximum light trespass / spill lighting of 2 lux ('post curfew' applicable as the proposed Site Application is for a Data Centre that will operate 24/7, the 'pre-curfew' values noted in ILP Guidance notes for the Reduction of Obtrusive Light Table 3, have been ignored) is being exceeded at specific locations along the existing biodiversity protection zone (ecological zone of influence).

Lighting from the proposed Application Site has the potential, without further lighting mitigation measures applied to certain column mounted (post-top) luminaires, to affect certain habitat areas adversely within the existing biodiversity protection zone from intrusion (light spill).

Mitigation measures mentioned in Section 5 to avoid nuisance associated with the spill lighting shall be implemented. The central principle of mitigation for operational lighting of the proposed Application Site is that the Lighting Design shall ensure light levels are, as far as possible, kept within the limitations set for obtrusive light for the appropriate ILP Environmental Zone.

Table 6: Obtrusive Light Calculations Results

Obtrusive Light Limitations for ILP Environmental Zone E3	External Lighting Design
LED lighting fixtures used throughout the development	All Luminaires proposed are of the LED energy efficient type.
Sky Glow ULR limit (max %) for ILP Environmental Zone E3 is 5%.	Columns at the proposed development are 3m & 5m in height. All External luminaires are mounted at 0 degrees with 0% upward light. No sky glow.
Light spill/ trespass / Intrusion limit (lux) into windows for ILP Environmental Zone E3 is 2 lux post-curfew	2 Lux is being <u>exceeded at certain locations</u> within the biodiversity protection zone (ecological zone of influence). Remaining areas are less than 1 lux. <u>Mitigation measures are required and shall be implemented.</u> There are no residential windows adjacent to the Application Site that are likely to receive levels of light intrusion above 1 lux resulting from the Site application external lighting design. <i>Note: The closest residential receptor are apartments (Nangorlea) located on the North, on the opposite side of New Nangor road, set-back and adjacent to the Circle K fuel service station.</i>
Building Luminance is not relevant in this case as we are not directly illuminating the building.	Not applicable

The class of site roadway lighting design intended for pedestrians and pedal cyclists on footways, cycleways, emergency lanes and other road areas lying separately or along the carriageway of a traffic route, and for residential roads, pedestrian streets, parking places, schoolyards etc is based on P class 'P1' requirements, as per IS EN 13201-2.

The proposed external lighting scheme has been specifically designed to reflect the worst case scenario. Where possible, the recommended limitations on obtrusive light stipulated in the outlined guidance notes & design standards have been adhered to. It is important to note that the lighting model is only able to accurately represent the effects of solid structures such as buildings and walls on light obtrusion. Non-solid barriers such as fences, trees, berms and hedges cannot be accurately modelled.

The Lighting Design prepared for external areas of the proposed Application Site seeks to be efficient; ensure safety and security for people moving in and around the Application Site; meets where possible the recognised design standards and guidance; whilst ensuring that light intrusion onto sensitive ecological habitat and glare onto nearby and internal road users is minimised or avoided where possible. The client has committed to ensure all mitigation measures have been implemented into the exterior lighting design.

7.0 Appendix A









Equinix DB8 - Rev C External Lighting Calculations

The data, calculations and information transmitted in this document are for guidance purposes only and are not legally binding. The calculations are based on requirements given to TRILUX at the time of design and where they are not available, reasonable assumptions may have been made. The liability or guarantee for the accuracy of these assumptions are not legally binding and TRILUX cannot accept responsibility for them. The calculation formulas and the product parameters are correct at time of data entry, however this does not guarantee the accuracy or completeness of the information supplied, changes and errors may occur from time to time and it is the responsibility of the specifier and installer to check that the information supplied by TRILUX is correct and relevant for the application.

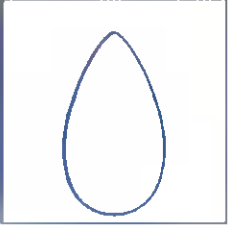
Date: 15.06.2021
Operator: CH

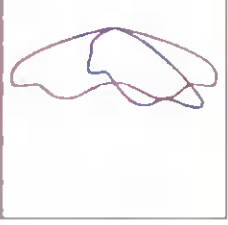
Operator
Telephone
Fax
e-Mail

Exterior Scene 1 / Luminaire parts list

6 Pieces	<p>TRILUX 8841 AB14L/850-740 2G1S (1060 mm) Article No.: Luminous flux (Luminaire): 800 lm Luminous flux (Lamps): 800 lm Luminaire Wattage: 7.0 W Luminaire classification according to CIE: 94 CIE flux code: 10 35 80 94 100 Fitting: 1 x 1 x LED ETDD (Correction Factor 1.000).</p>		
4 Pieces	<p>TRILUX Amatrix G3 C04 WR 1400-840 01 Article No.: Luminous flux (Luminaire): 1400 lm Luminous flux (Lamps): 1400 lm Luminaire Wattage: 13.0 W Luminaire classification according to CIE: 100 CIE flux code: 82 95 99 100 100 Fitting: 1 x 1 x LED ET (Correction Factor 1.000).</p>		
45 Pieces	<p>TRILUX Jovie 70-AB7L/10000-740 8G1 Article No.: Luminous flux (Luminaire): 9999 lm Luminous flux (Lamps): 10000 lm Luminaire Wattage: 83.0 W Luminaire classification according to CIE: 100 CIE flux code: 34 71 96 100 100 Fitting: 1 x 1 x LED ETDD (Correction Factor 1.000).</p>		
4 Pieces	<p>TRILUX 6900240; LnStar 40-AM2L/3200-740 4G1S ET Article No.: 6900240; Luminous flux (Luminaire): 3200 lm Luminous flux (Lamps): 3200 lm Luminaire Wattage: 21.0 W Luminaire classification according to CIE: 100 CIE flux code: 48 88 99 100 100 Fitting: 1 x LED (Correction Factor 1.000).</p>		
74 Pieces	<p>TRILUX 7076540; Combial 30-AM9R/7500-740 1G1W ET Article No.: 7076540; Luminous flux (Luminaire): 7398 lm Luminous flux (Lamps): 7500 lm Luminaire Wattage: 75.0 W Luminaire classification according to CIE: 100 CIE flux code: 53 86 99 100 99 Fitting: 1 x LED (Correction Factor 1.000).</p>		

Operator
Telephone
Fax
e-Mail

Exterior Scene 1 / Luminaire parts list

4 Pieces TRILUX 7116540; OlevonF 1200 2300-840 PC ET
Article No.: 7116540;
Luminous flux (Luminaire): 2600 lm
Luminous flux (Lamps): 2600 lm
Luminaire Wattage: 19.0 W
Luminaire classification according to CIE: 94
CIE flux code: 47 76 92 94 100
Fitting: 1 x LED (Correction Factor 1.000).

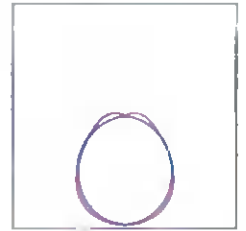

1 Pieces TRILUX 7243140; Jovie 50-AB2L-LR/3200-740 4G1 ET
Article No.: 7243140;
Luminous flux (Luminaire): 3199 lm
Luminous flux (Lamps): 3200 lm
Luminaire Wattage: 27.0 W
Luminaire classification according to CIE: 100
CIE flux code: 34 71 95 100 100
Fitting: 1 x LED (Correction Factor 1.000).

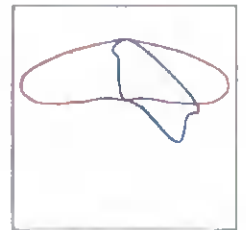

10 Pieces TRILUX 7319251; 7319600; 7319700; 7319800;
7319900; 7320100; 7320200; 6609800; 6609900;
8841 RB/800-730 (1060 mm) ETDD
Article No.: 7319251; 7319600; 7319700;
7319800; 7319900; 7320100; 7320200; 6609800;
6609900;
Luminous flux (Luminaire): 800 lm
Luminous flux (Lamps): 800 lm
Luminaire Wattage: 8.5 W
Luminaire classification according to CIE: 99
CIE flux code: 33 73 94 99 100
Fitting: 1 x LED (Correction Factor 1.000).

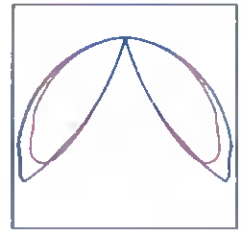

77 Pieces TRILUX Skeo Curv 1800 lumen
Article No.:
Luminous flux (Luminaire): 1823 lm
Luminous flux (Lamps): 1825 lm
Luminaire Wattage: 12.9 W
Luminaire classification according to CIE: 99
CIE flux code: 44 78 97 99 100
Fitting: 1 x User defined (Correction Factor 1.000).

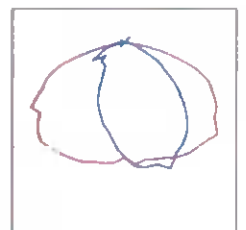

Operator
Telephone
Fax
e-Mail

Exterior Scene 1 / 3D Rendering



Operator
Telephone
Fax
e-Mail

Exterior Scene 1 / False Colour Rendering

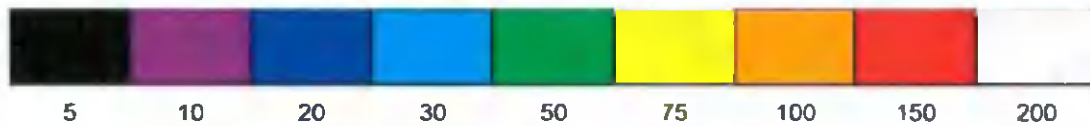

lx

Operator
 Telephone
 Fax
 e-Mail

Exterior Scene 1 / Roadway/Car Park / Surface 1 / Isolines (E)

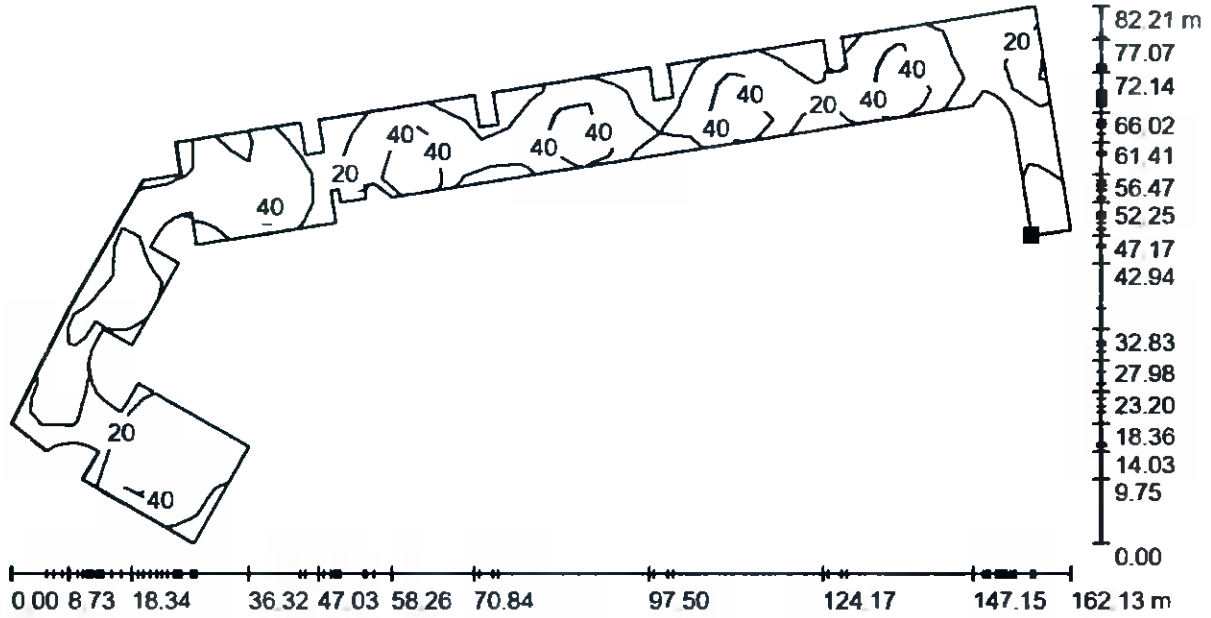

Values in Lux, Scale 1 : 1160

Position of surface in external scene:
 Marked point:
 (321.774 m, 171.608 m, 0.000 m)



Grid: 39 x 15 Points

E_{av} [lx]	E_{min} [lx]	E_{max} [lx]	$u0$	E_{min} / E_{max}
32	9.86	75	0.305	0.132

Operator
Telephone
Fax
e-Mail

Exterior Scene 1 / Roadway / Surface 1 / Isolines (E)

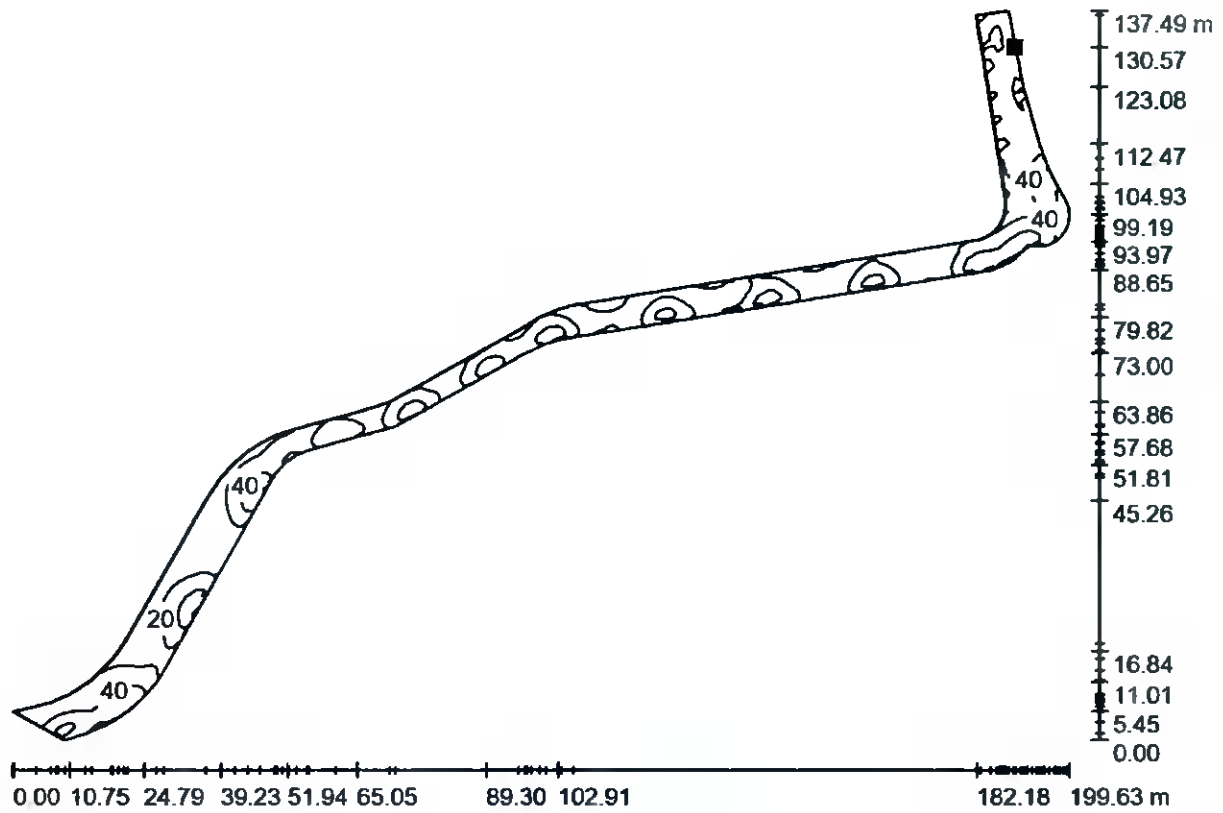

Values in Lux, Scale 1 : 1428

Position of surface in external scene:
Marked point:
(329.032 m, 165.492 m, 0.000 m)



Grid: 128 x 128 Points

E_{av} [lx]	E_{min} [lx]	E_{max} [lx]	u_0	E_{min} / E_{max}
35	7.45	75	0.213	0.099

Operator
Telephone
Fax
e-Mail

Exterior Scene 1 / Roadway / Surface 1 / Isolines (E)

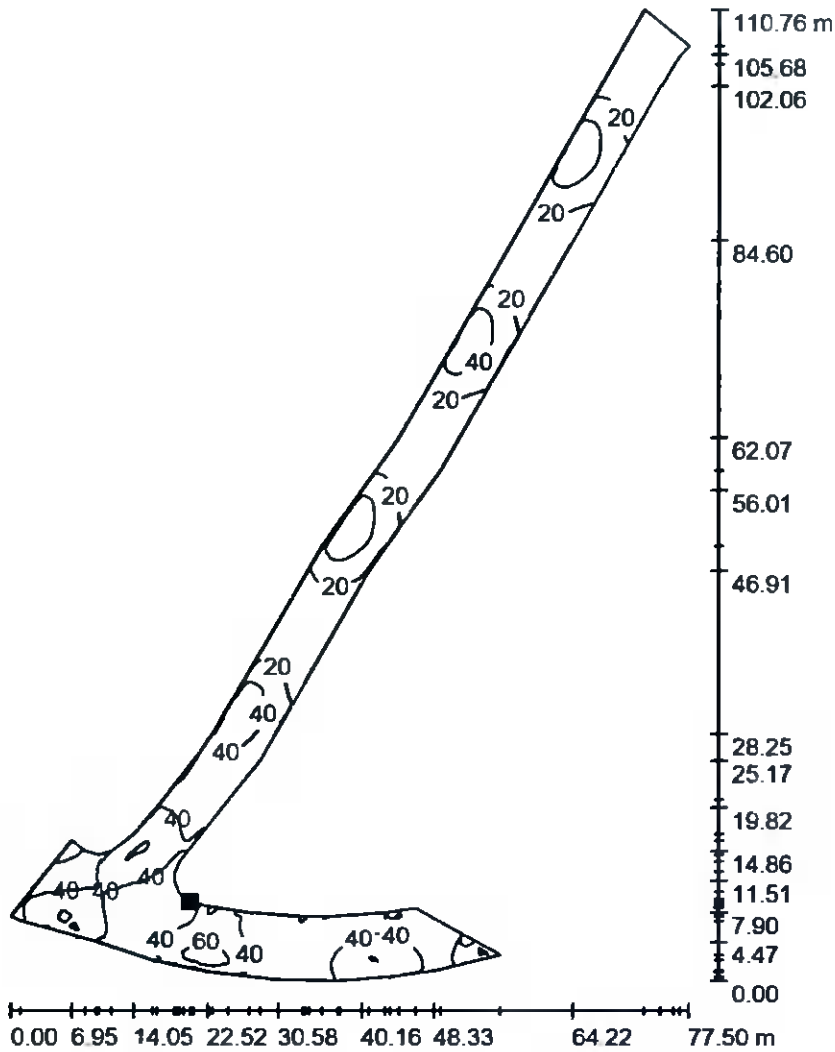

Values in Lux, Scale 1 : 867

Position of surface in external scene:
Marked point:
(113.796 m, 41.054 m, 0.000 m)

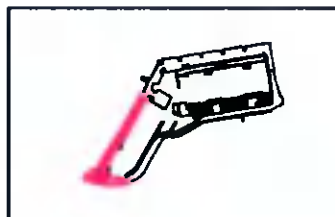

Grid: 128 x 128 Points

E_{av} [lx]	E_{min} [lx]	E_{max} [lx]	u0	E_{min} / E_{max}
32	8.08	67	0.255	0.121

Operator
Telephone
Fax
e-Mail

Exterior Scene 1 / Pedestrian Walkway / Surface 1 / Isolines (E)

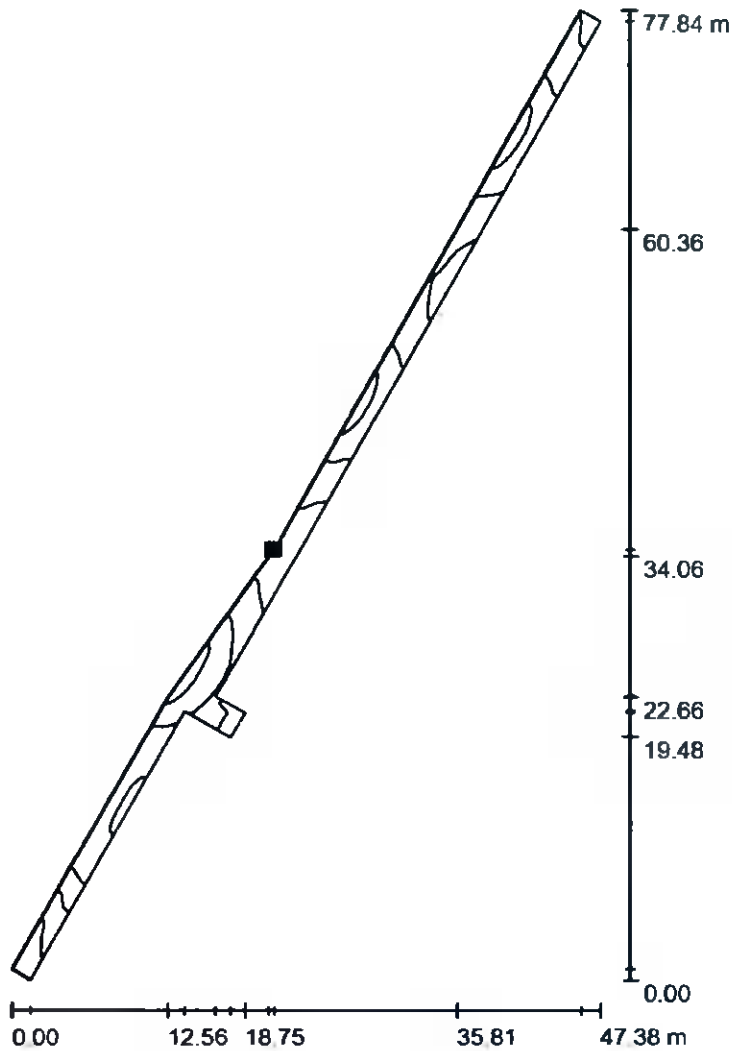

Values in Lux, Scale 1 : 609

Position of surface in external scene:
Marked point:
(142.781 m, 90.859 m, 0.000 m)

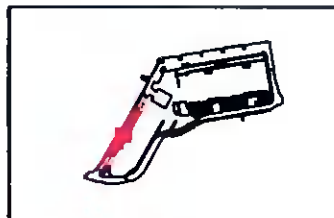

Grid: 128 x 128 Points

E_{av} [lx]
14

E_{min} [lx]
7.89

E_{max} [lx]
28

$u0$
0.545

E_{min} / E_{max}
0.281

Operator
Telephone
Fax
e-Mail

Exterior Scene 1 / Pedestrian Walkway / Surface 2 / Isolines (E)

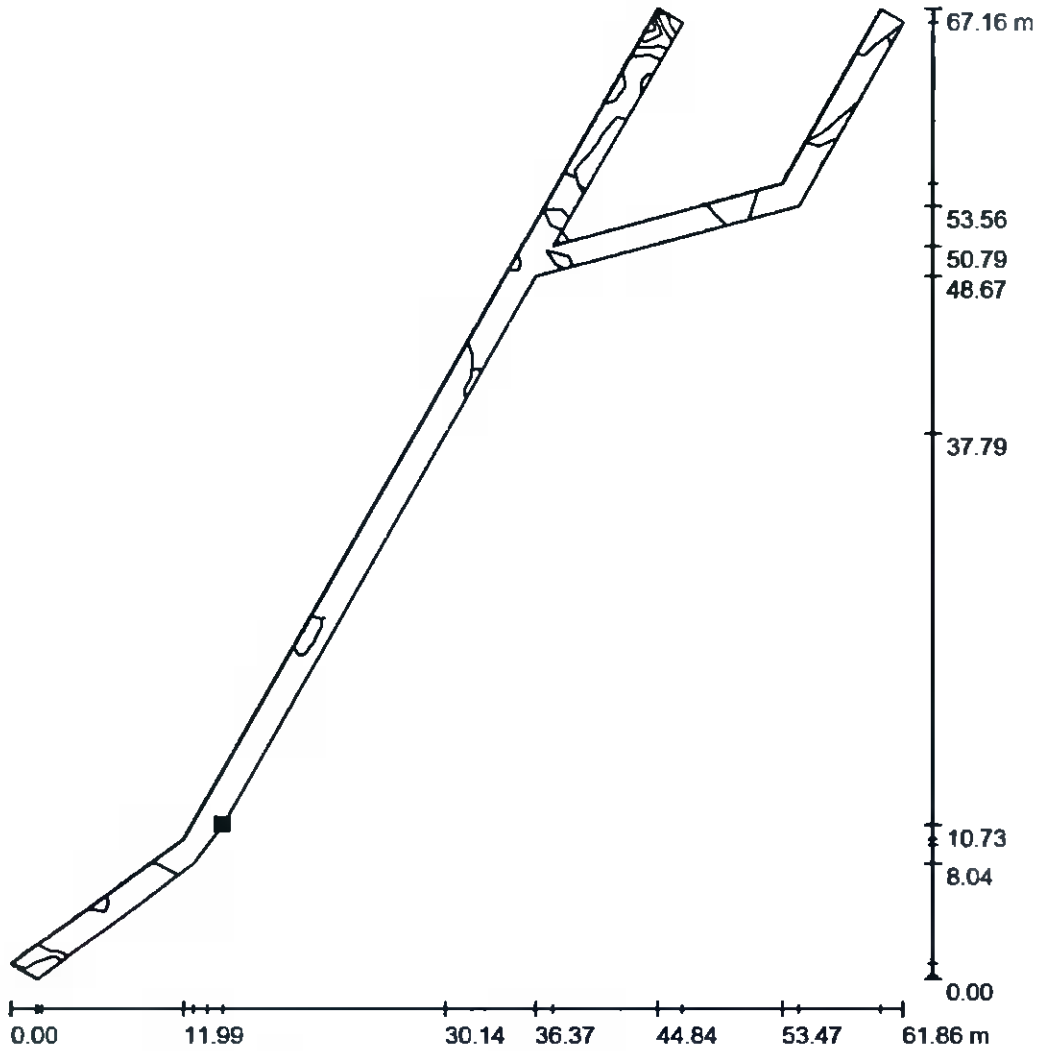

Values in Lux, Scale 1 : 526

Position of surface in external scene:
Marked point:
(160.508 m, 53.123 m, 0.000 m)



Grid: 79 x 7 Points

E_{av} [lx]
16

E_{min} [lx]
6.29

E_{max} [lx]
52

u_0
0.397

E_{min} / E_{max}
0.121

Operator
Telephone
Fax
e-Mail

Exterior Scene 1 / Pedestrian Walkway / Surface 1 / Isolines (E)

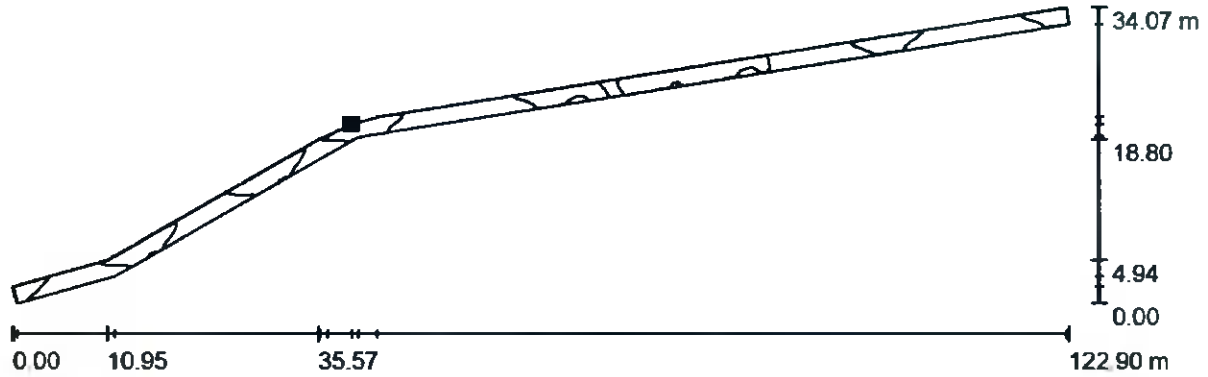

Values in Lux, Scale 1 : 879

Position of surface in external scene:
Marked point:
(240.235 m, 109.765 m, 0.000 m)

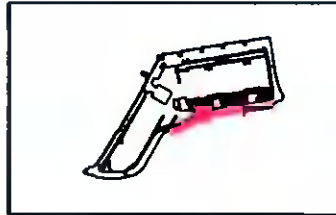

Grid: 128 x 128 Points

E_{av} [lx]	E_{min} [lx]	E_{max} [lx]	u_0	E_{min} / E_{max}
37	7.17	155	0.193	0.046

Operator
 Telephone
 Fax
 e-Mail

Exterior Scene 1 / Pedestrian Walkway / Surface 1 / Isolines (E)

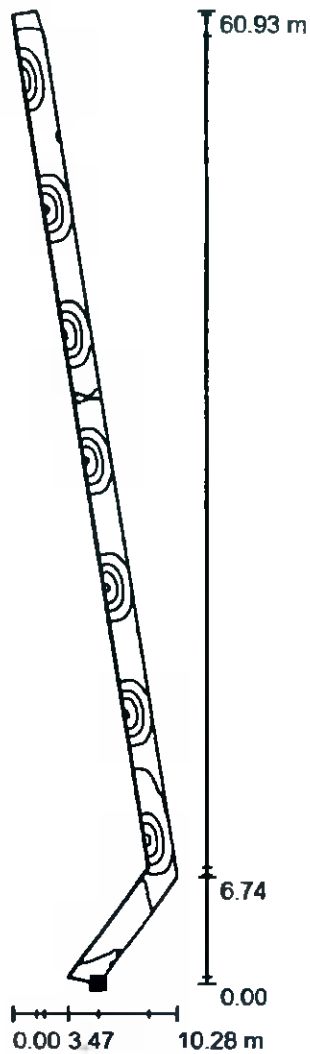

Values in Lux, Scale 1 : 477

Position of surface in external scene:
 Marked point:
 (322.398 m, 129.506 m, 0.000 m)



Grid: 128 x 128 Points

E_{av} [lx]	E_{min} [lx]	E_{max} [lx]	u0	E_{min} / E_{max}
61	19	161	0.304	0.115

Operator
 Telephone
 Fax
 e-Mail

Exterior Scene 1 / Pedestrian Walkway / Surface 1 / Isolines (E)

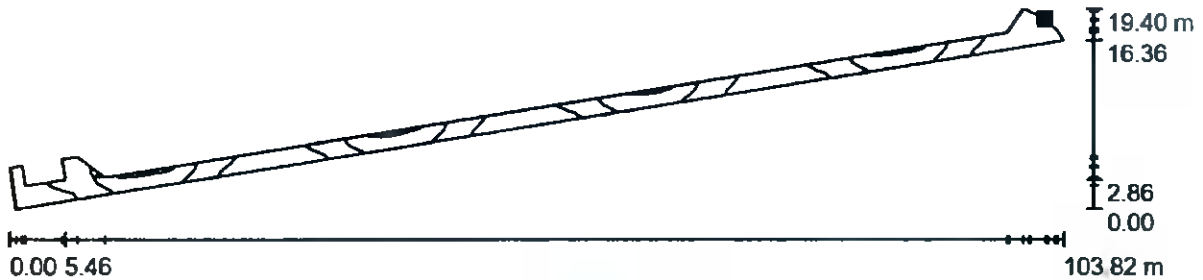

Values in Lux, Scale 1 : 743

Position of surface in external scene:
 Marked point:
 (316.507 m, 192.850 m, 0.000 m)

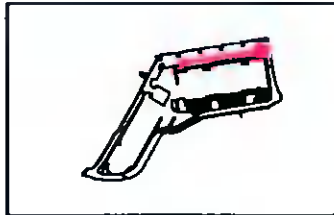

Grid: 128 x 128 Points

E_{av} [lx]	E_{min} [lx]	E_{max} [lx]	u0	E_{min} / E_{max}
30	9.48	66	0.314	0.144

Operator
Telephone
Fax
e-Mail

Exterior Scene 1 / Fire Escape Route / Surface 1 / Isolines (E)

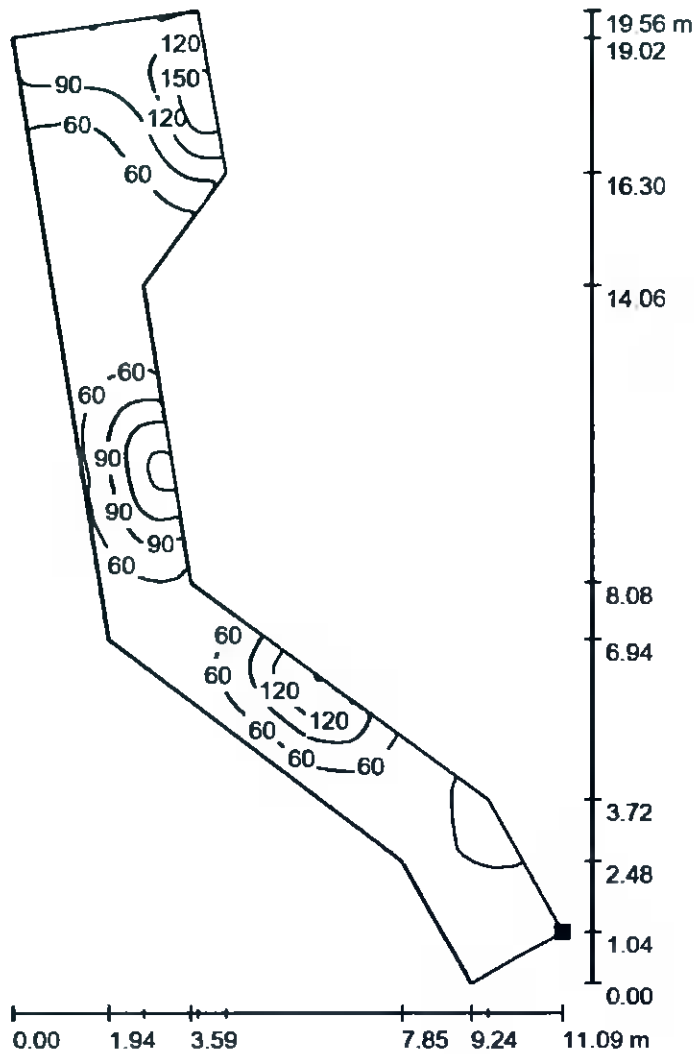

Values in Lux, Scale 1 : 153

Position of surface in external scene:
Marked point:
(233.628 m, 112.029 m, 0.000 m)

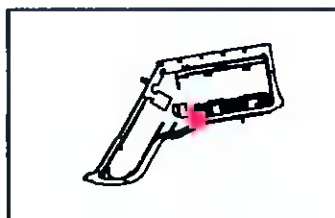

Grid: 128 x 128 Points

E_{av} [lx]
67

E_{min} [lx]
28

E_{max} [lx]
172

$u0$
0.418

E_{min} / E_{max}
0.163

Operator
Telephone
Fax
e-Mail

Exterior Scene 1 / Bicycle Parking / Surface 1 / Isolines (E)

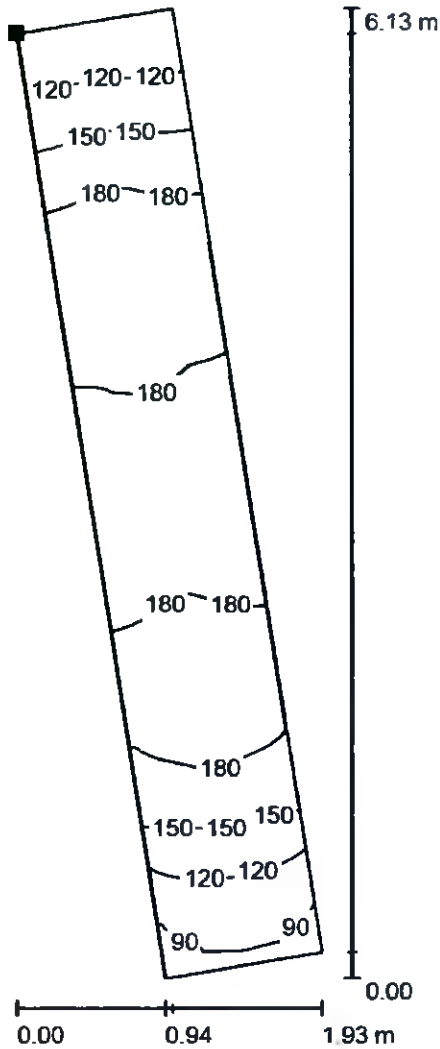

Values in Lux, Scale 1 : 48

Position of surface in external scene:
Marked point:
(206.453 m, 169.236 m, 0.000 m)



Grid: 128 x 128 Points

E_{av} [lx]
161

E_{min} [lx]
82

E_{max} [lx]
210

u_0
0.512

E_{min} / E_{max}
0.392

Operator
Telephone
Fax
e-Mail

Exterior Scene 1 / Loading Bays / Surface 1 / Isolines (E)

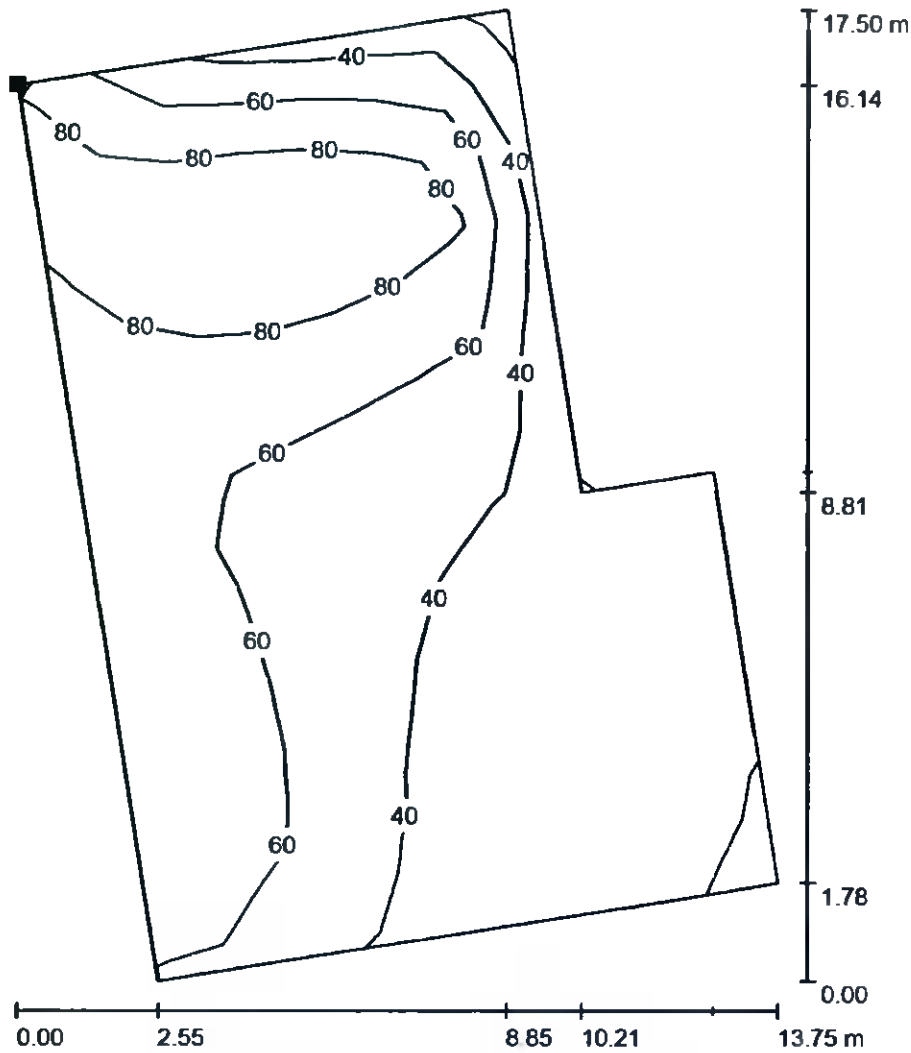

Values in Lux, Scale 1 : 137

Position of surface in external scene:
Marked point:
(209.438 m, 131.049 m, 0.000 m)

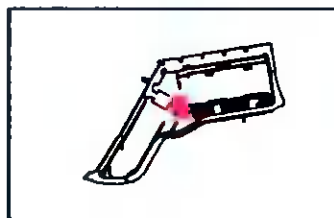

Grid: 13 x 9 Points

E_{av} [lx]	E_{min} [lx]	E_{max} [lx]	$u0$	E_{min} / E_{max}
55	20	105	0.357	0.187

Operator
Telephone
Fax
e-Mail

Exterior Scene 1 / HGV Rejection Area / Surface 1 / Isolines (E)

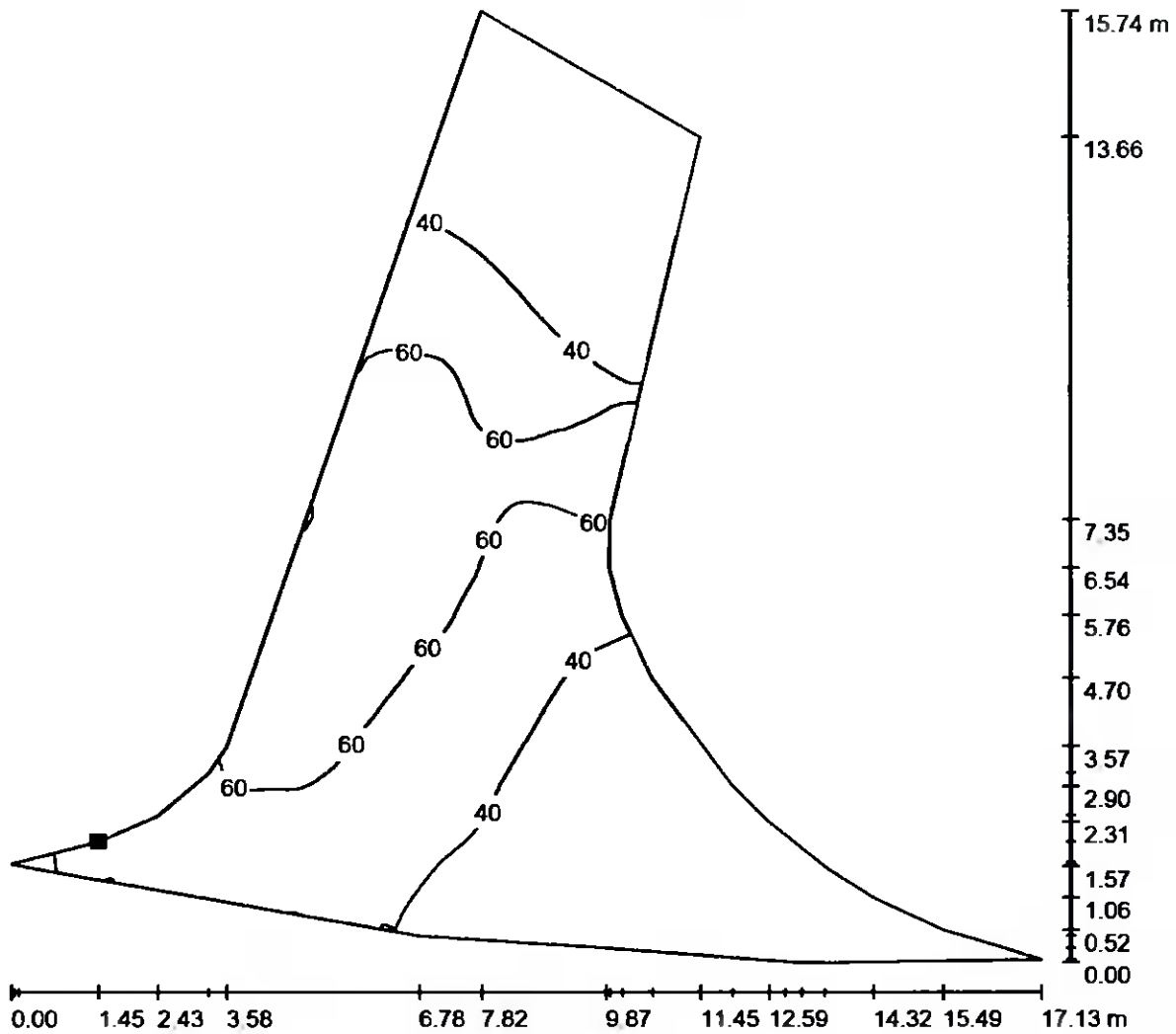

Values in Lux, Scale 1 : 124

Position of surface in external scene:
Marked point:
(115.244 m, 41.424 m, 0.000 m)

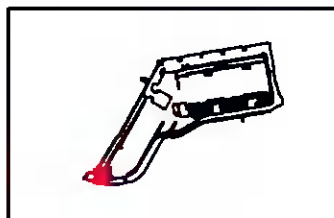

Grid: 128 x 128 Points

E_{av} [lx]
45

E_{min} [lx]
22

E_{max} [lx]
80

$u0$
0.482

E_{min} / E_{max}
0.271

Operator
Telephone
Fax
e-Mail

Exterior Scene 1 / Pedestrians/Cyclists Gate Pathway / Surface 1 / Isolines (E)

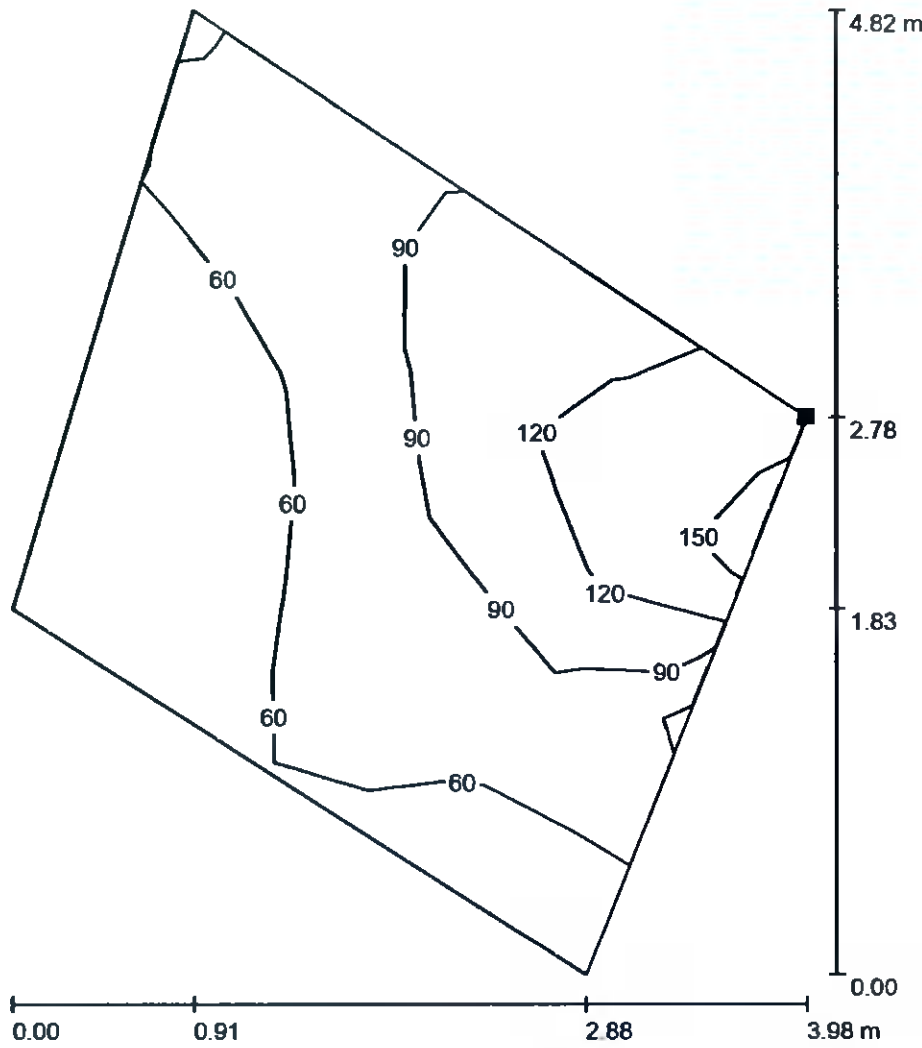

Values in Lux, Scale 1 : 38

Position of surface in external scene:
Marked point:
(168.595 m, 162.821 m, 0.000 m)

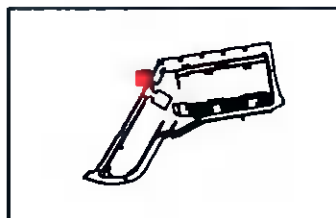

Grid: 9 x 7 Points

E_{av} [lx]	E_{min} [lx]	E_{max} [lx]	$u0$	E_{min} / E_{max}
82	35	163	0.421	0.212

Operator
Telephone
Fax
e-Mail

Exterior Scene 1 / Under Canopy / Surface 1 / Isolines (E)

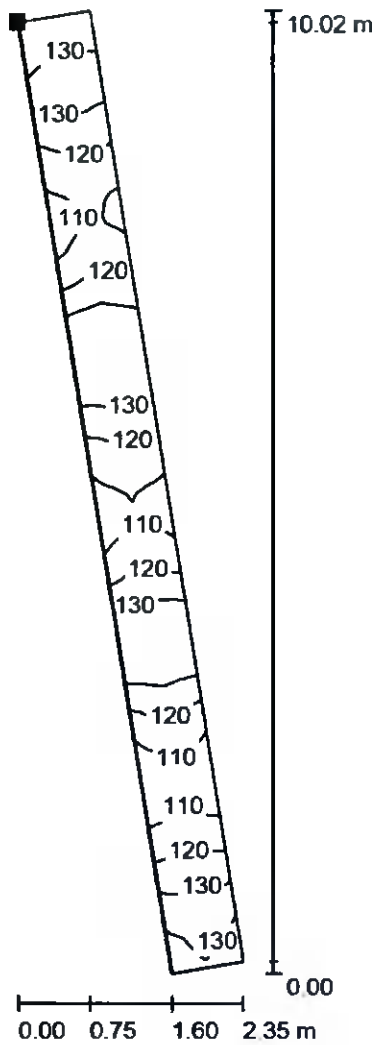

Values in Lux, Scale 1 : 79

Position of surface in external scene:
Marked point:
(208.426 m, 159.695 m, 0.000 m)

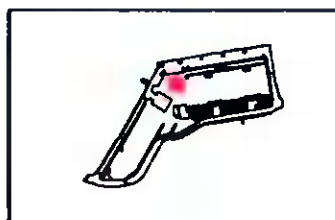

Grid: 128 x 128 Points

E_{av} [lx]
122

E_{min} [lx]
104

E_{max} [lx]
140

$u0$
0.854

E_{min} / E_{max}
0.746

Operator
Telephone
Fax
e-Mail

Exterior Scene 1 / Mantrap / Surface 1 / Isolines (E)

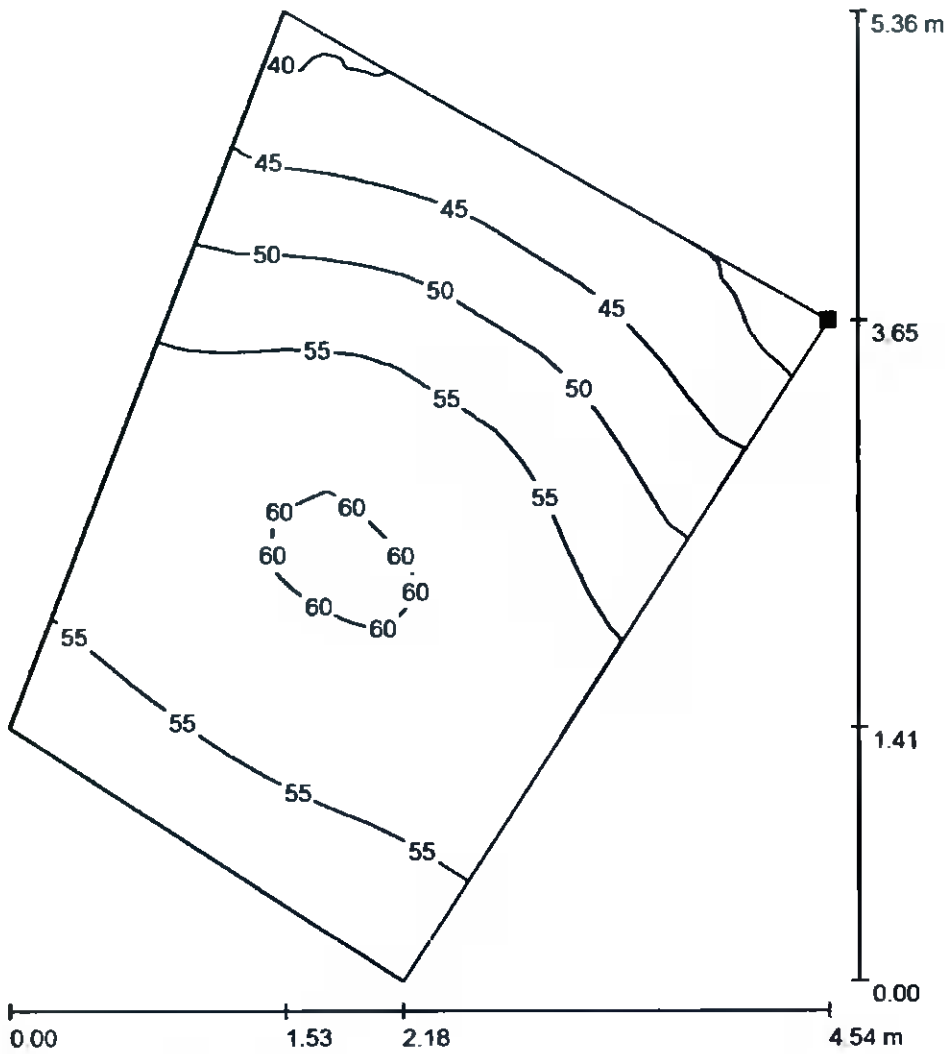

Values in Lux, Scale 1 : 42

Position of surface in external scene:
Marked point:
(172.871 m, 162.051 m, 0.000 m)

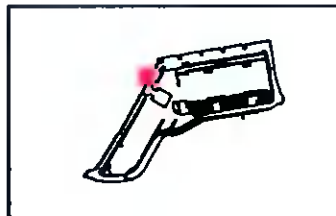

Grid: 128 x 128 Points

E_{av} [lx]
53

E_{min} [lx]
39

E_{max} [lx]
61

$u0$
0.747

E_{min} / E_{max}
0.650

Operator
Telephone
Fax
e-Mail

Exterior Scene 1 / Gens Plant Yard 1.1 - Walkways / Surface 1 / Isolines (E)

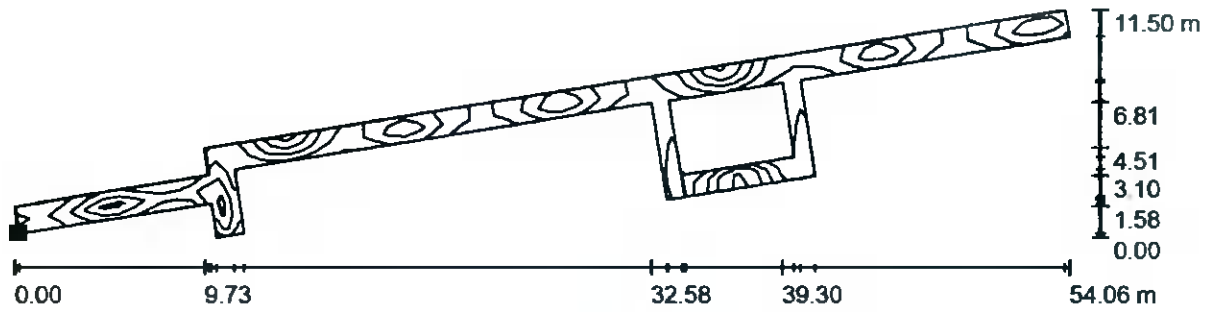

Values in Lux, Scale 1 : 387

Position of surface in external scene:

Marked point:
(209.781 m, 164.976 m, 0.000 m)



Grid: 73 x 9 Points

E_{av} [lx]
191

E_{min} [lx]
37

E_{max} [lx]
423

$u0$
0.191

E_{min} / E_{max}
0.086

Operator
Telephone
Fax
e-Mail

Exterior Scene 1 / Gens Plant Yard 1.1 - Walkways / Surface 1 / Isolines (E)

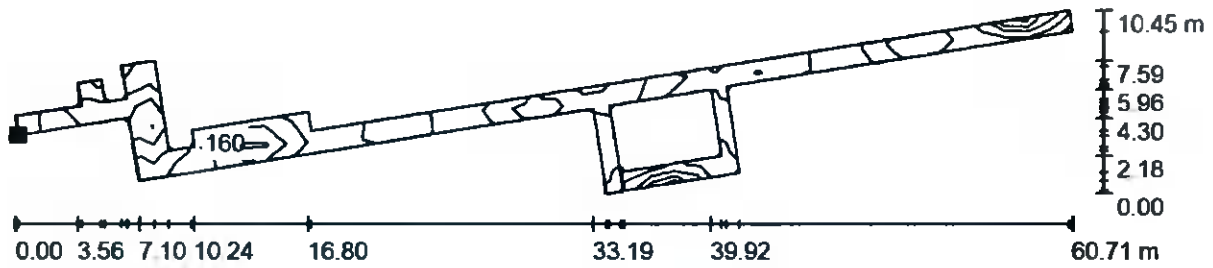

Values in Lux, Scale 1 : 435

Position of surface in external scene:
Marked point:
(256.709 m, 177.491 m, 0.000 m)

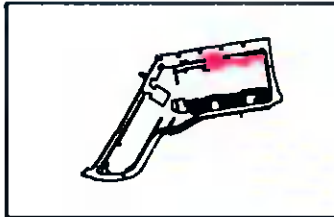

Grid: 47 x 7 Points

E_{av} [lx]	E_{min} [lx]	E_{max} [lx]	u0	E_{min} / E_{max}
200	55	452	0.276	0.122

Operator
Telephone
Fax
e-Mail

Exterior Scene 1 / Chillers Plant Yard 1.1 - Walkways / Surface 1 / Isolines (E)

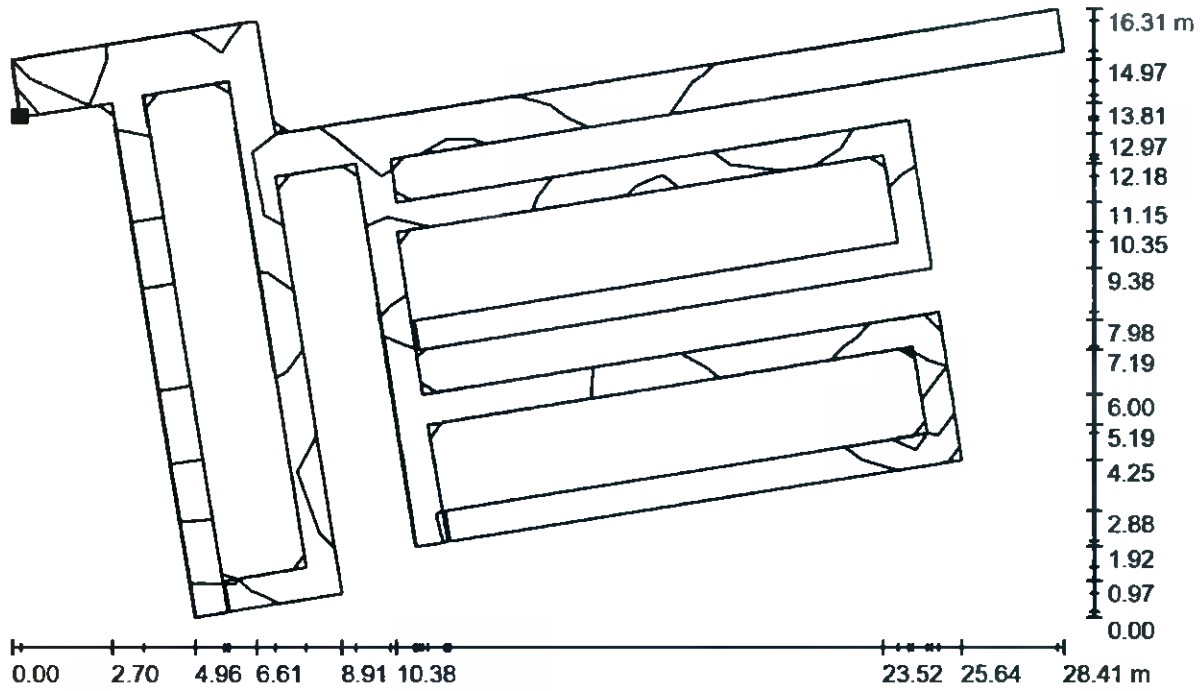

Values in Lux, Scale 1 : 204

Position of surface in external scene:
Marked point:
(227.204 m, 129.148 m, 0.000 m)

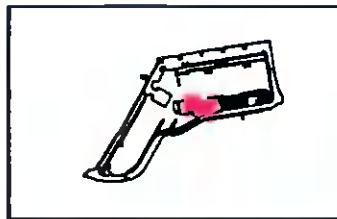

Grid: 15 x 9 Points

E_{av} [lx]
207

E_{min} [lx]
49

E_{max} [lx]
439

u_0
0.236

E_{min} / E_{max}
0.111

Operator
Telephone
Fax
e-Mail

Exterior Scene 1 / Chillers Plant Yard 1.1 - Walkways / Surface 1 / Isolines (E)

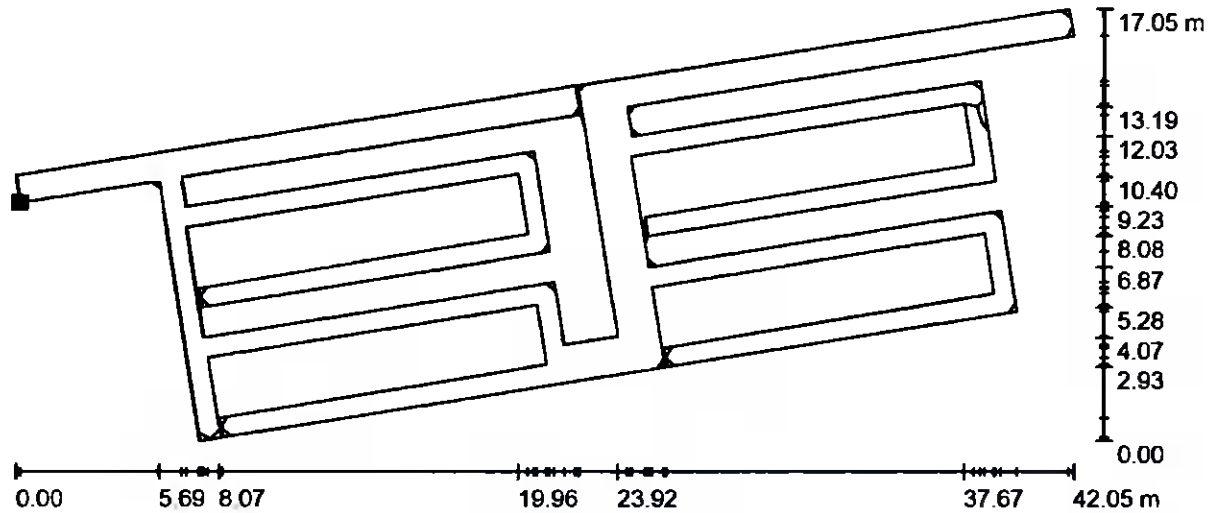

Values in Lux, Scale 1 : 301

Position of surface in external scene:
Marked point:
(255.440 m, 130.925 m, 0.000 m)

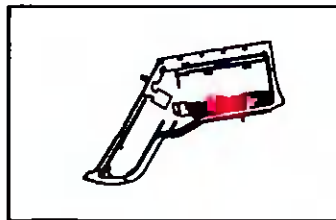

Grid: 27 x 7 Points

E_{av} [lx]
183

E_{min} [lx]
59

E_{max} [lx]
446

$u0$
0.325

E_{min} / E_{max}
0.133

Operator
Telephone
Fax
e-Mail

Exterior Scene 1 / Chillers Plant Yard 1.1 - Walkways / Surface 1 / Isolines (E)

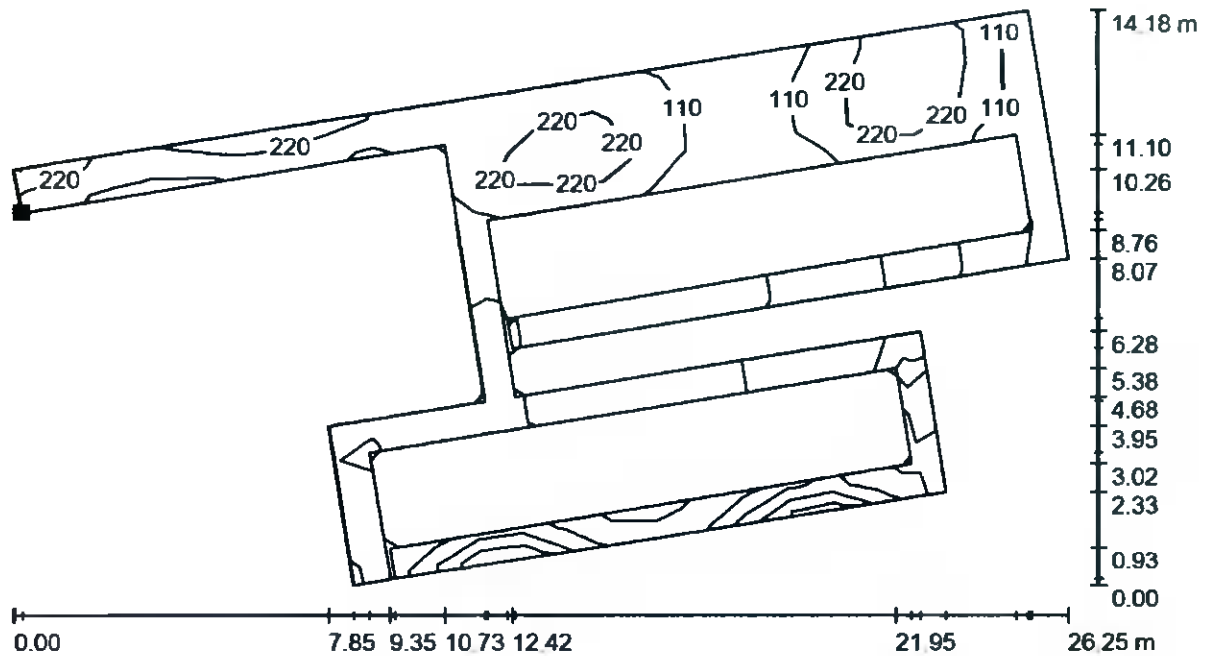

Values in Lux, Scale 1 : 188

Position of surface in external scene:
Marked point:
(297.348 m, 137.542 m, 0.000 m)



Grid: 23 x 11 Points

E_{av} [lx]	E_{min} [lx]	E_{max} [lx]	$u0$	E_{min} / E_{max}
208	34	556	0.163	0.061

Operator
 Telephone
 Fax
 e-Mail

Exterior Scene 1 / Chillers Plant Yard 1.1 - Walkways / Surface 1 / Isolines (E)

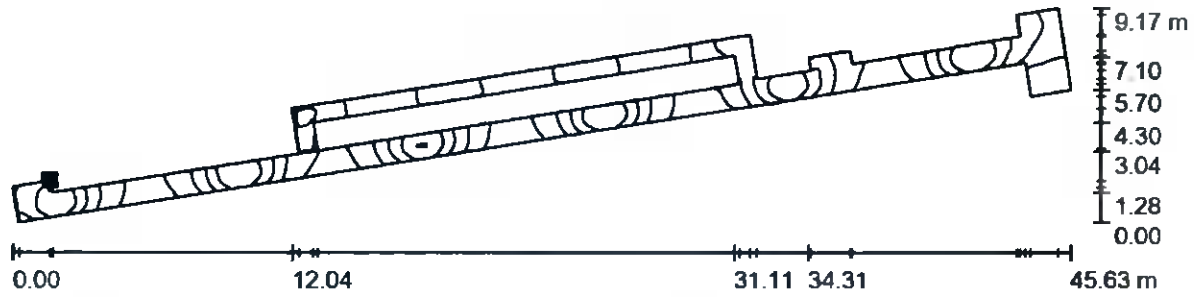

Values in Lux, Scale 1 : 327

Position of surface in external scene:

Marked point:
 (235.333 m, 132.014 m, 0.000 m)

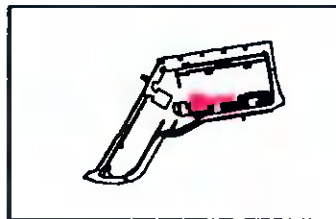

Grid: 128 x 128 Points

E_{av} [lx]	E_{min} [lx]	E_{max} [lx]	$u0$	E_{min} / E_{max}
190	40	462	0.210	0.086

Operator
 Telephone
 Fax
 e-Mail

Exterior Scene 1 / Chillers Plant Yard 1.1 - Walkways / Surface 1 / Isolines (E)

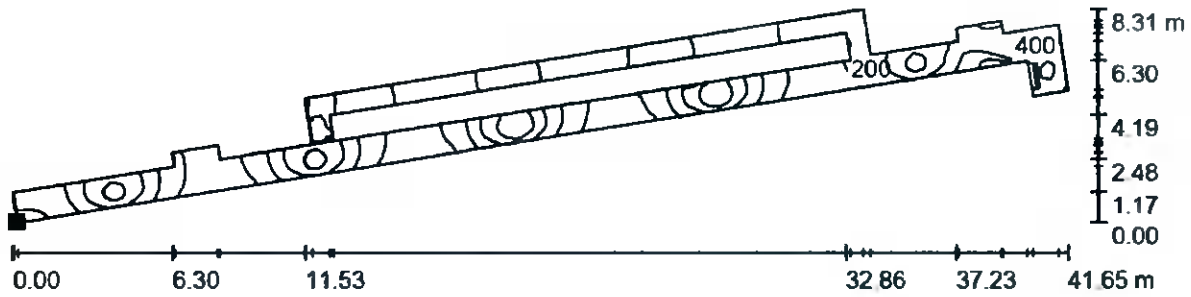

Values in Lux, Scale 1 : 298

Position of surface in external scene:
 Marked point:
 (279.158 m, 137.285 m, 0.000 m)



Grid: 128 x 128 Points

E_{av} [lx]	E_{min} [lx]	E_{max} [lx]	$u0$	E_{min} / E_{max}
195	31	525	0.158	0.059

Operator
Telephone
Fax
e-Mail

Exterior Scene 1 / Ramps / Surface 1 / Isolines (E)

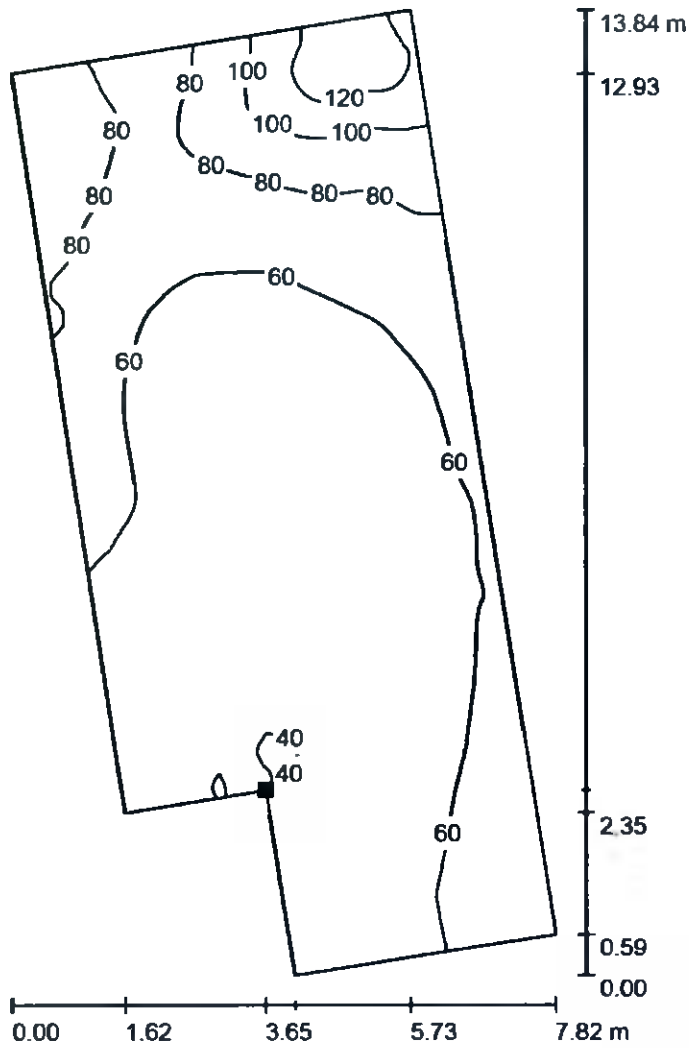

Values in Lux, Scale 1 : 109

Position of surface in external scene:
Marked point:
(206.642 m, 119.745 m, 0.000 m)

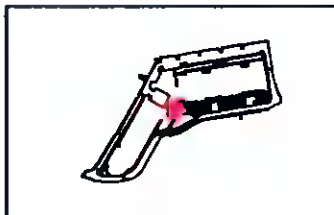

Grid: 128 x 128 Points

E_{av} [lx]
62

E_{min} [lx]
39

E_{max} [lx]
134

$u0$
0.627

E_{min} / E_{max}
0.288

Operator
Telephone
Fax
e-Mail

Exterior Scene 1 / Sprinkler Compound / Surface 1 / Isolines (E)

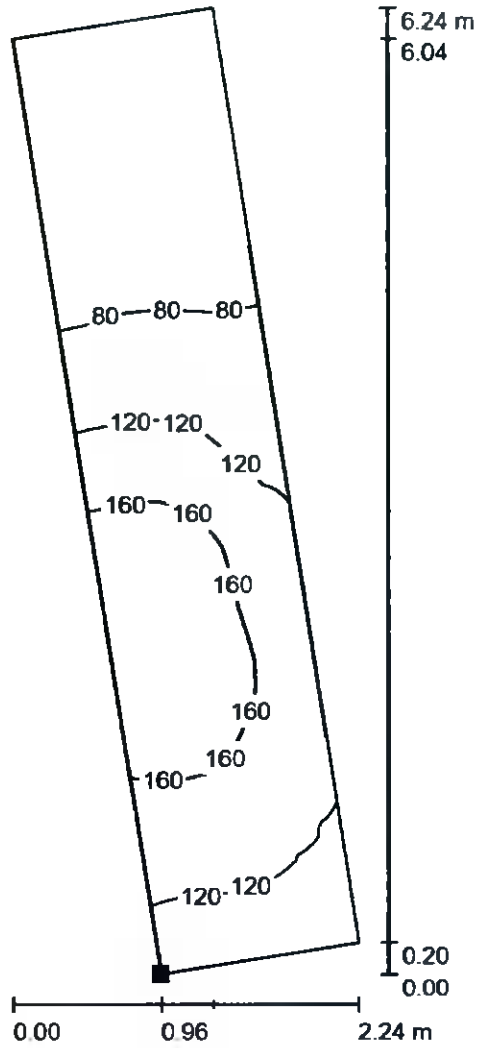

Values in Lux, Scale 1 : 49

Position of surface in external scene:
Marked point:
(289.066 m, 109.611 m, 0.000 m)



Grid: 128 x 128 Points

E_{av} [lx]	E_{min} [lx]	E_{max} [lx]	$u0$	E_{min} / E_{max}
113	44	198	0.389	0.222

Operator
Telephone
Fax
e-Mail

Exterior Scene 1 / Smoke Shelter / Surface 1 / Isolines (E)

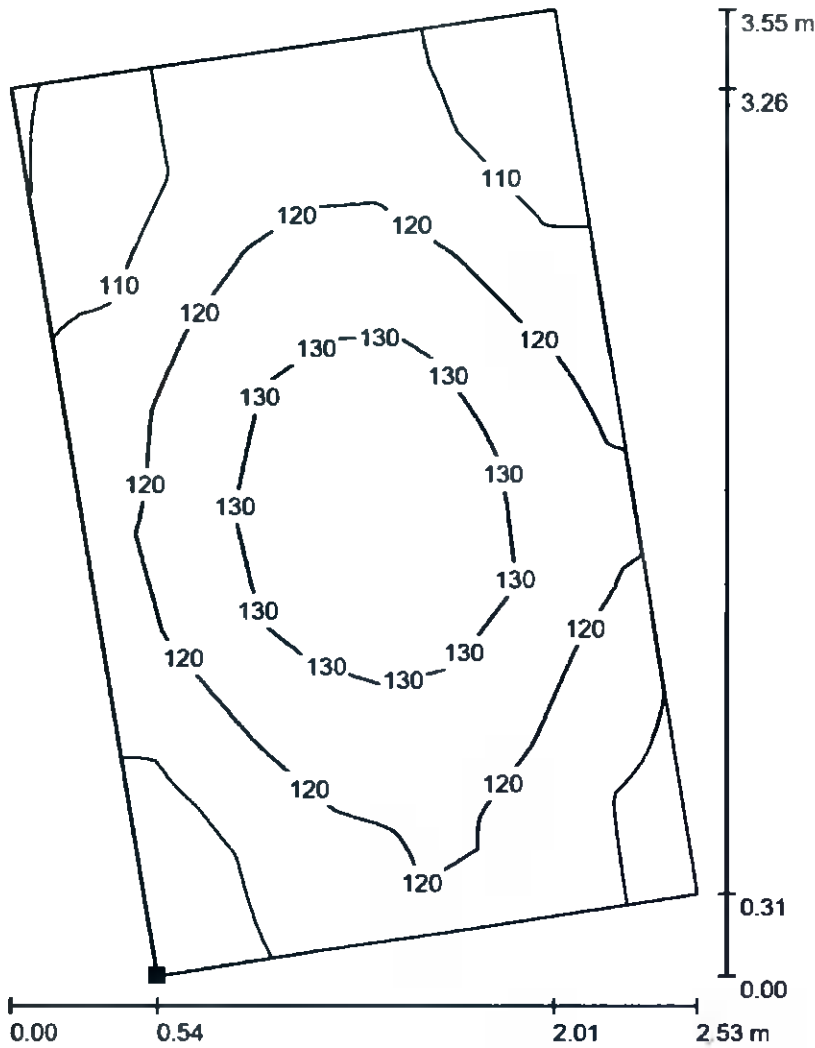

Values in Lux, Scale 1 : 28

Position of surface in external scene:
Marked point:
(185.943 m, 181.000 m, 0.000 m)

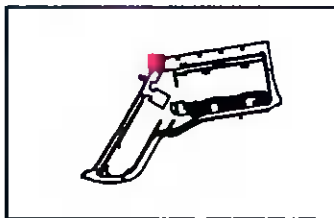

Grid: 128 x 128 Points

E_{av} [lx]
119

E_{min} [lx]
99

E_{max} [lx]
139

u_0
0.832

E_{min} / E_{max}
0.715

Operator
Telephone
Fax
e-Mail

Exterior Scene 1 / Planning data

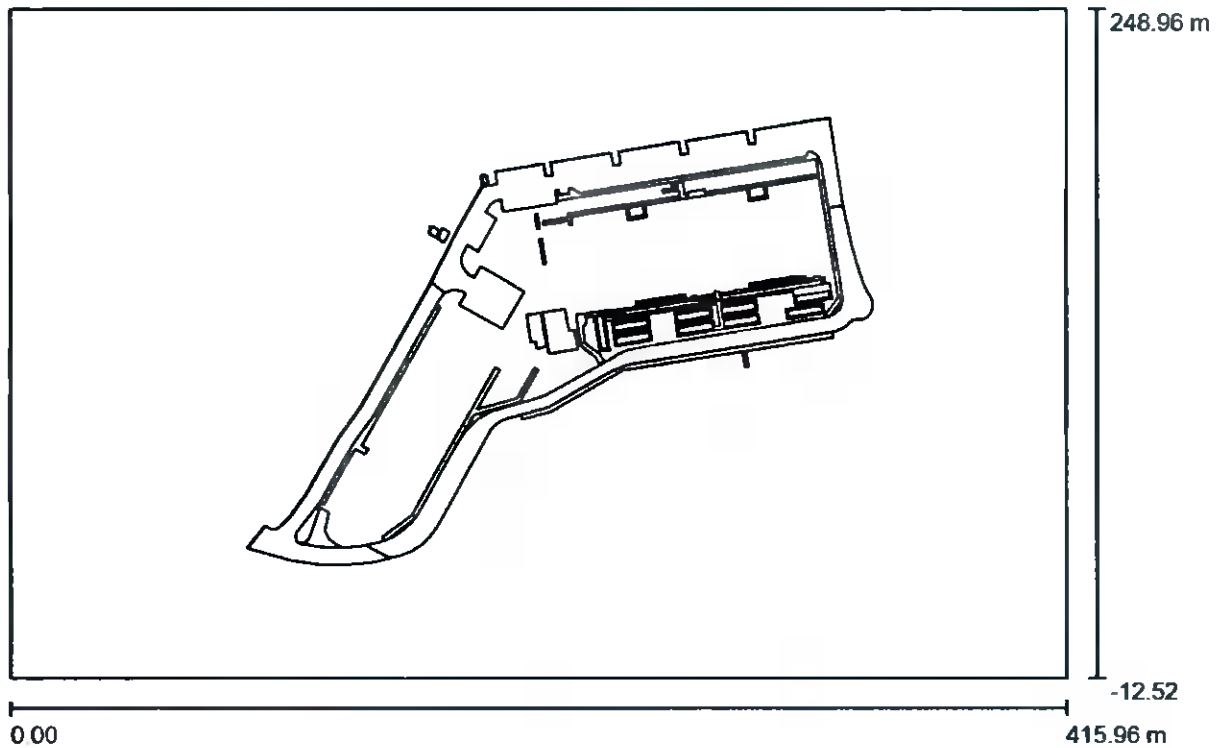

Maintenance factor: 0.80, **ULR (Upward Light Ratio): 0.0%**

Scale 1:2974

Luminaire Parts List

No.	Pieces	Designation (Correction Factor)	Φ (Luminaire) [lm]	Φ (Lamps) [lm]	P [W]
1	6	TRILUX 8841 AB14L/850-740 2G1S (660 mm) (1.000)	800	800	7.0
2	4	TRILUX Amatrix G3 C04 WR 1400-840 01 (1.000)	1400	1400	13.0
3	45	TRILUX Jovie 70-AB7L/10000-740 8G1 (1.000)	9999	10000	83.0
4	4	TRILUX 6900240; LnStar 40-AM2L/3200-740 4G1S ET (1.000)	3200	3200	21.0
5	74	TRILUX 7076540; Combial 30-AM9R/7500-740 1G1W ET (1.000)	7398	7500	75.0

Operator
 Telephone
 Fax
 e-Mail

Exterior Scene 1 / Planning data

Luminaire Parts List

No.	Pieces	Designation (Correction Factor)	Φ (Luminaire) [lm]	Φ (Lamps) [lm]	P [W]
6	4	TRILUX 7116540; OIveonF 1200 2300-840 PC ET (1.000)	2600	2600	19.0
7	1	TRILUX 7243140; Jovie 50-AB2L-LR/3200- 740 4G1 ET (1.000)	3199	3200	27.0
8	10	TRILUX 7319251; 7319600; 7319700; 7319800; 7319900; 7320100; 7320200; 6609800; 6609900; 8841 RB/800-730 (1060 mm) ETDD (1.000)	800	800	8.5
9	77	TRILUX Skeo Curv 1800 lumen (1.000)	1823	1825	12.9
			Total: 1182573	Total: 1190311	10644.3

Operator
Telephone
Fax
e-Mail

Exterior Scene 1 / Spill Light / Surface 1 / Value Chart (E)

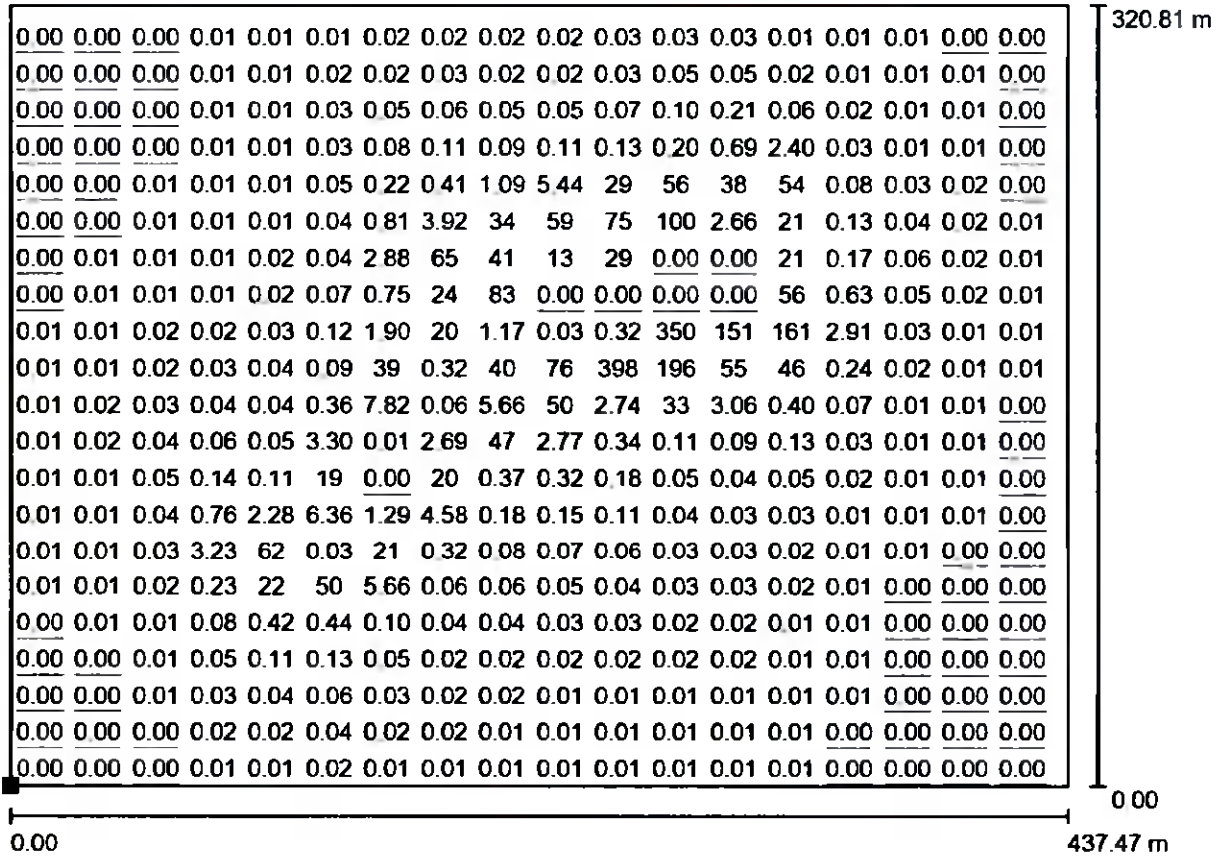

Values in Lux, Scale 1 : 3128

Not all calculated values could be displayed.

Position of surface in external scene:
Marked point:
(1.000 m, -49.104 m, 0.000 m)



Grid: 128 x 128 Points

E_{av} [lx]	E_{min} [lx]	E_{max} [lx]	$u0$	E_{min} / E_{max}
4.78	0.00	542	0.000	0.000

Operator
Telephone
Fax
e-Mail

Exterior Scene 1 / Vertical Surface - Site Boundary / Isolines (E, Perpendicular)



Values in Lux, Scale 1 : 322

Position of surface in external scene:
Marked point:
(230.850 m, 67.592 m, 2.500 m)



Grid: 16 x 1 Points

E_{av} [lx]	E_{min} [lx]	E_{max} [lx]	$u0$	E_{min} / E_{max}
0.98	0.61	1.72	0.618	0.352

Operator
Telephone
Fax
e-Mail

Exterior Scene 1 / Vertical Surface - Site Boundary / Value Chart (E, Perpendicular)

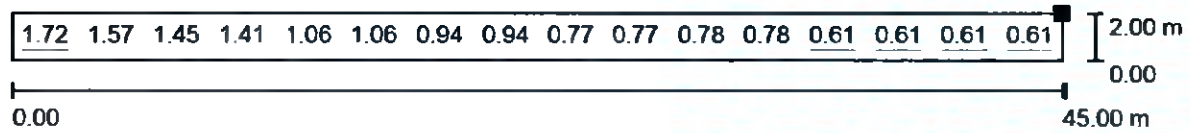

Values in Lux, Scale 1 : 322

Position of surface in external scene:
Marked point:
(230.850 m, 67.592 m, 2.500 m)

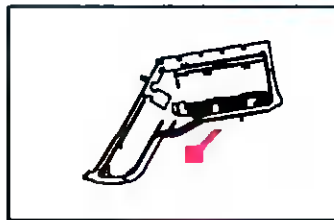

Grid: 16 x 1 Points

E_{av} [lx]	E_{min} [lx]	E_{max} [lx]	$u0$	E_{min} / E_{max}
0.98	0.61	1.72	0.618	0.352

Operator
Telephone
Fax
e-Mail

Exterior Scene 1 / Vertical Surface - Site Boundary / Isolines (E, Perpendicular)

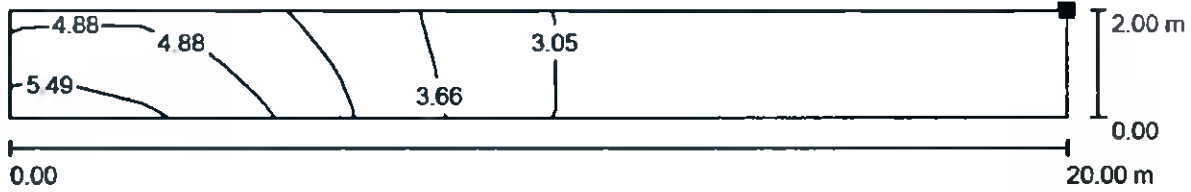

Values in Lux, Scale 1 : 143

Position of surface in external scene:
Marked point:
(268.040 m, 100.849 m, 2.500 m)

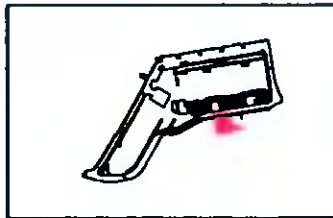

Grid: 16 x 2 Points

E_{av} [lx]
3.65

E_{min} [lx]
2.69

E_{max} [lx]
5.75

u0
0.738

E_{min} / E_{max}
0.468

Operator
Telephone
Fax
e-Mail

Exterior Scene 1 / Vertical Surface - Site Boundary / Value Chart (E, Perpendicular)

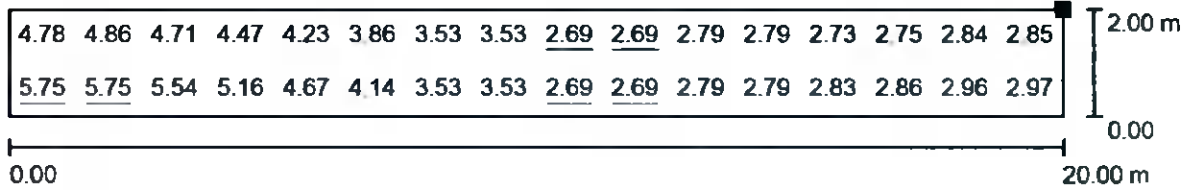

Values in Lux, Scale 1 : 143

Position of surface in external scene:
Marked point:
(268.040 m, 100.849 m, 2.500 m)

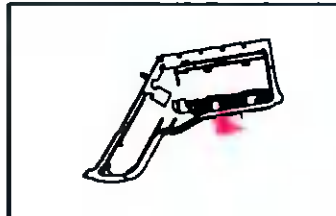

Grid: 16 x 2 Points

E_{av} [lx]	E_{min} [lx]	E_{max} [lx]	u_0	E_{min} / E_{max}
3.65	2.69	5.75	0.738	0.468

Operator
Telephone
Fax
e-Mail

Exterior Scene 1 / Vertical Surface - Site Boundary / Isolines (E, Perpendicular)



Values in Lux, Scale 1 : 501

Position of surface in external scene:
Marked point:
(292.024 m, 97.403 m, 2.500 m)

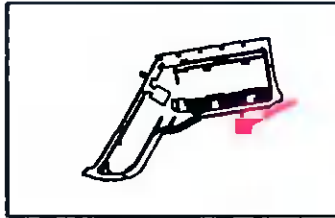

Grid: 64 x 2 Points

E_{av} [lx]	E_{min} [lx]	E_{max} [lx]	$u0$	E_{min} / E_{max}
4.36	1.94	8.93	0.446	0.218

Operator
Telephone
Fax
e-Mail

Exterior Scene 1 / Vertical Surface - Site Boundary / Greyscale (E, Perpendicular)

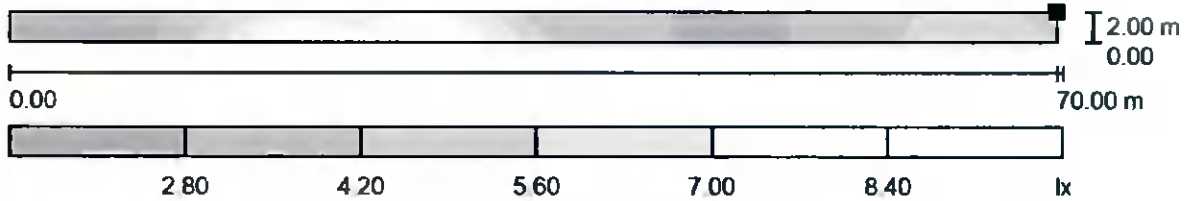

Scale 1 : 501

Position of surface in external scene:
Marked point:
(292.024 m, 97.403 m, 2.500 m)

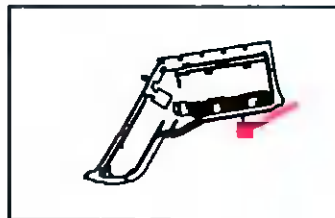

Grid: 64 x 2 Points

E_{av} [lx]
4.36

E_{min} [lx]
1.94

E_{max} [lx]
8.93

u_0
0.446

E_{min} / E_{max}
0.218

Operator
Telephone
Fax
e-Mail

Exterior Scene 1 / Vertical Surface - Site Boundary / Isolines (E, Perpendicular)

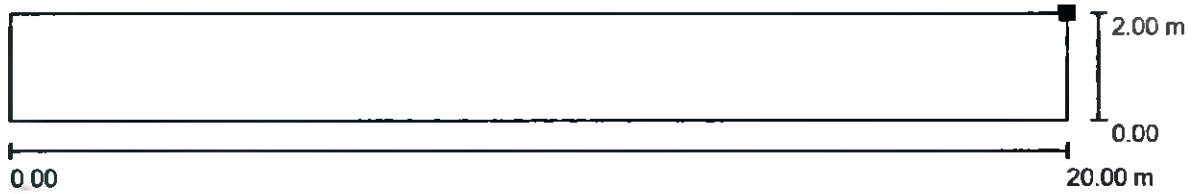

Values in Lux, Scale 1 : 143

Position of surface in external scene:
Marked point:
(203.282 m, 78.830 m, 2.500 m)

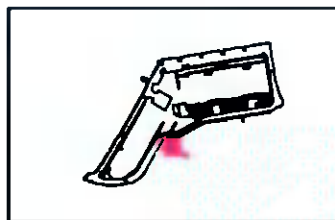

Grid: 8 x 1 Points

E_{av} [lx]	E_{min} [lx]	E_{max} [lx]	$u0$	E_{min} / E_{max}
1.32	0.89	1.82	0.674	0.488

Operator
Telephone
Fax
e-Mail

Exterior Scene 1 / Vertical Surface - Site Boundary / Greyscale (E, Perpendicular)

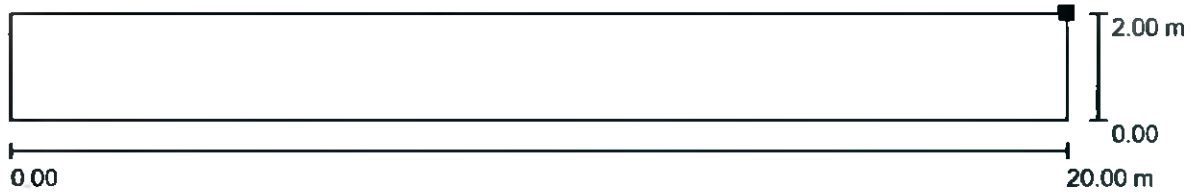

Scale 1 : 143

Position of surface in external scene:
Marked point:
(203.282 m, 78.830 m, 2.500 m)

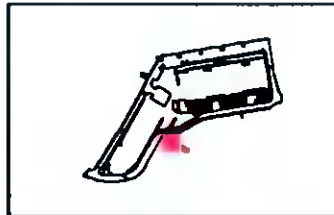

Grid: 8 x 1 Points

E_{av} [lx]	E_{min} [lx]	E_{max} [lx]	$u0$	E_{min} / E_{max}
1.32	0.89	1.82	0.674	0.488

Operator
Telephone
Fax
e-Mail

Exterior Scene 1 / Vertical Surface - Site Boundary / Isolines (E, Perpendicular)

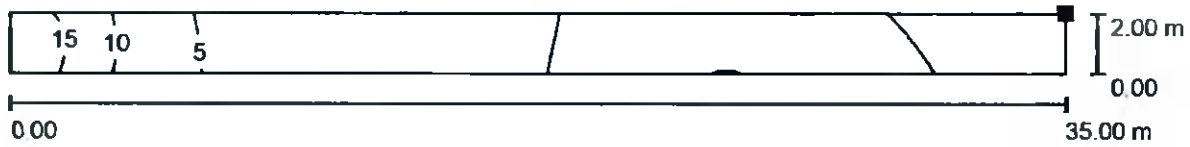

Values in Lux, Scale 1 : 251

Position of surface in external scene:
Marked point:
(177.626 m, 46.445 m, 2.500 m)

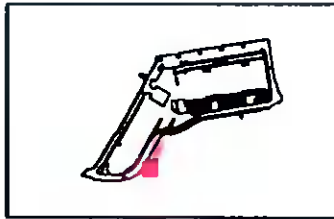

Grid: 64 x 4 Points

E_{av} [lx]	E_{min} [lx]	E_{max} [lx]	$u0$	E_{min} / E_{max}
6.04	2.50	18	0.413	0.137

Operator
 Telephone
 Fax
 e-Mail

Exterior Scene 1 / Vertical Surface - Site Boundary / Value Chart (E, Perpendicular)

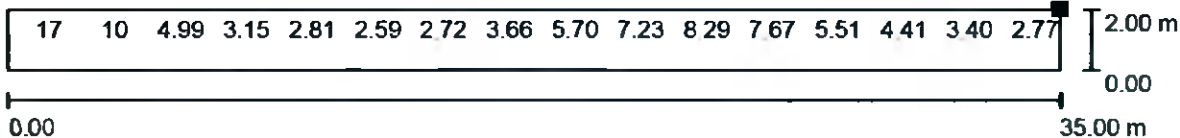

Values in Lux, Scale 1 : 251

Not all calculated values could be displayed.

Position of surface in external scene:
 Marked point:
 (177.626 m, 46.445 m, 2.500 m)

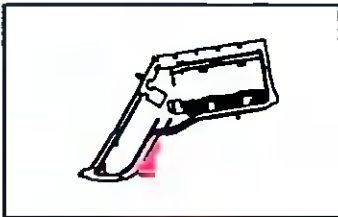

Grid: 64 x 4 Points

E_{av} [lx]	E_{min} [lx]	E_{max} [lx]	u0	E_{min} / E_{max}
6.04	2.50	18	0.413	0.137

Operator
Telephone
Fax
e-Mail

Exterior Scene 1 / Typical Biodiversity Zone / Isolines (E, Perpendicular)

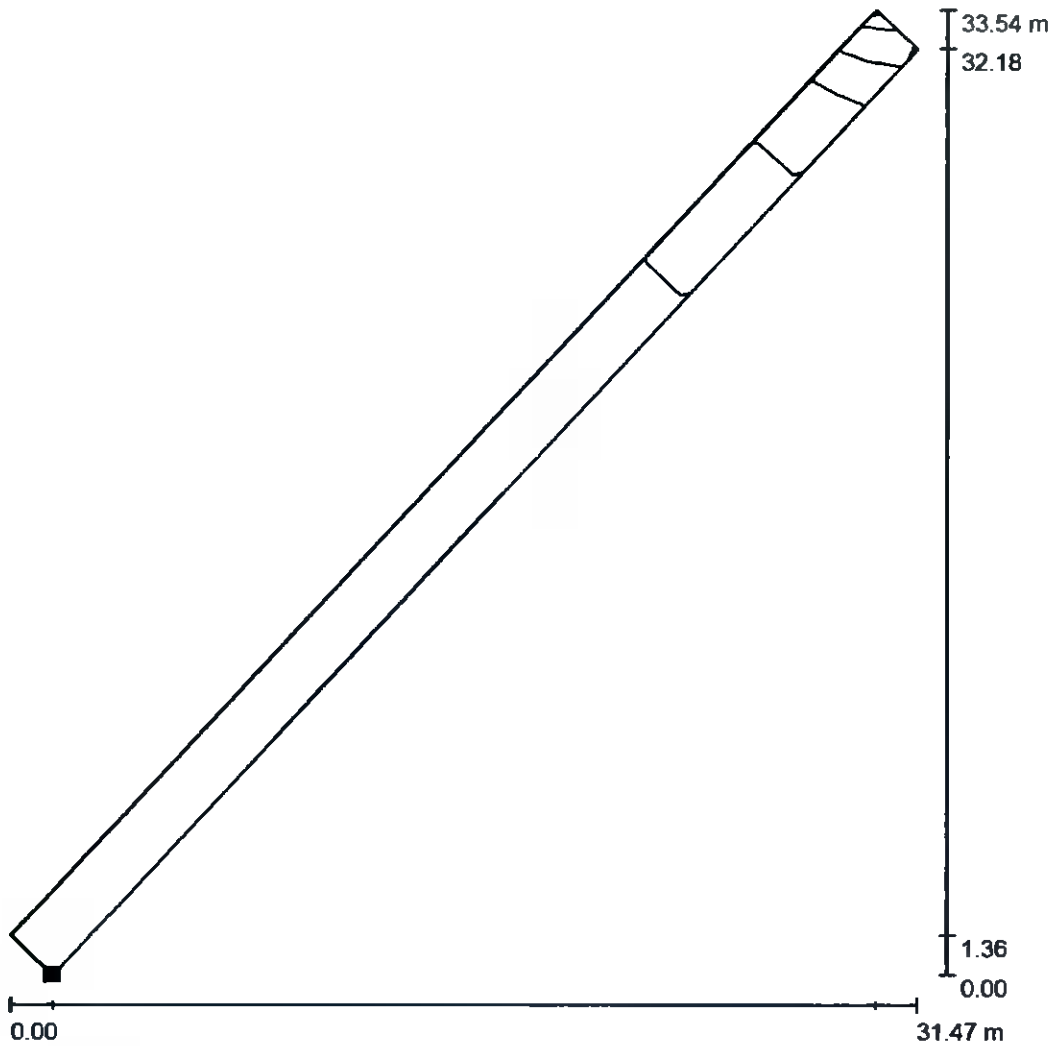

Values in Lux, Scale 1 : 263

Position of surface in external scene:
Marked point:
(232.240 m, 71.011 m, 0.000 m)



Grid: 32 x 2 Points

E_{av} [lx]
0.38

E_{min} [lx]
0.11

E_{max} [lx]
2.11

u_0
0.295

E_{min} / E_{max}
0.054

Operator
Telephone
Fax
e-Mail

Exterior Scene 1 / Typical Biodiversity Zone / Greyscale (E, Perpendicular)

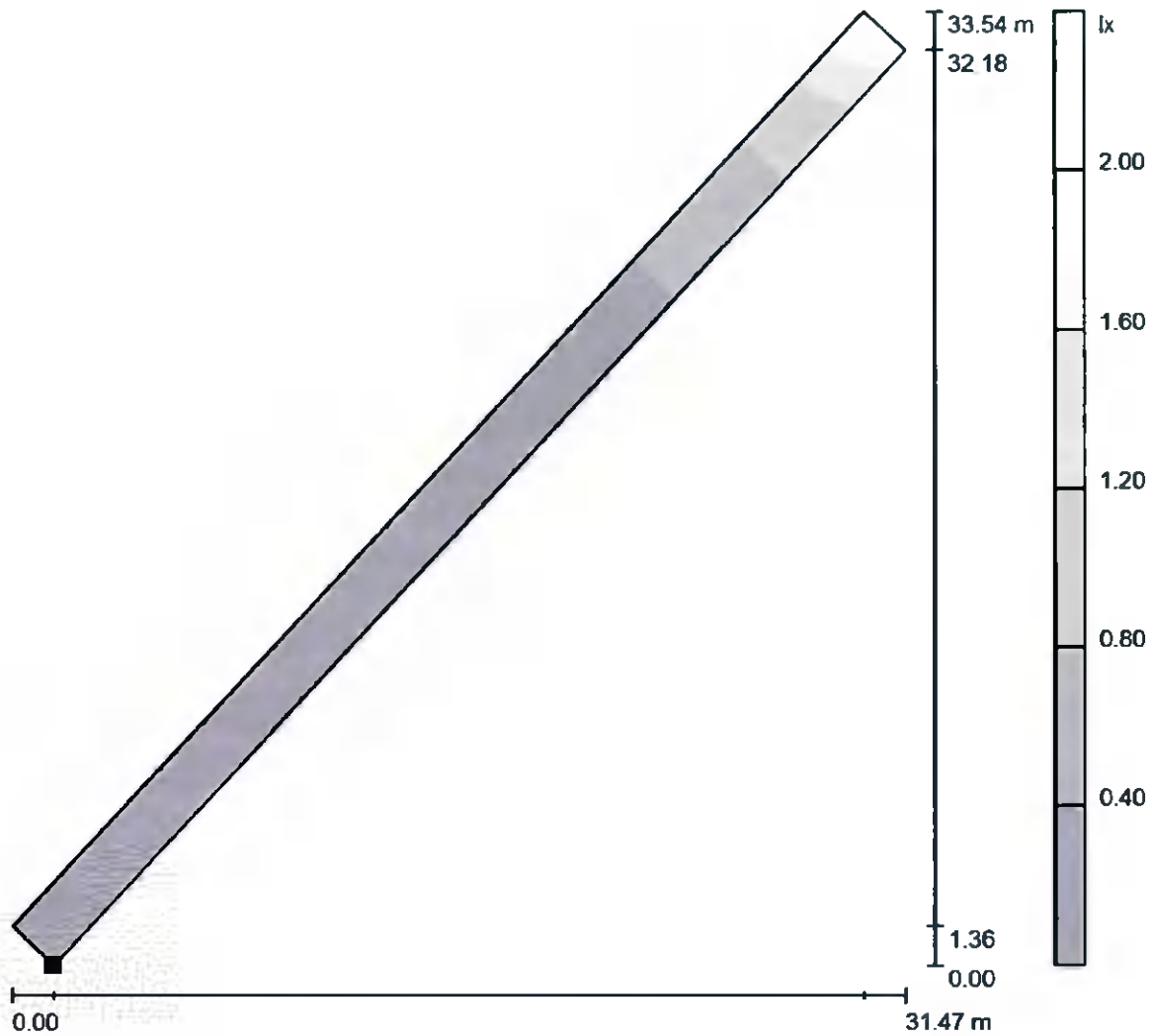

Position of surface in external scene:
Marked point:
(232.240 m, 71.011 m, 0.000 m)

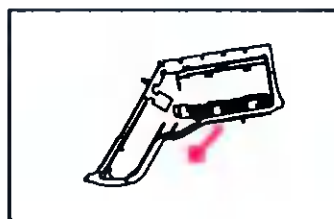

Scale 1 : 263

Grid: 32 x 2 Points

E_{av} [lx]
0.38

E_{min} [lx]
0.11

E_{max} [lx]
2.11

u_0
0.295

E_{min} / E_{max}
0.054

Operator
Telephone
Fax
e-Mail

Exterior Scene 1 / Typical Biodiversity Zone / Isolines (E, Perpendicular)

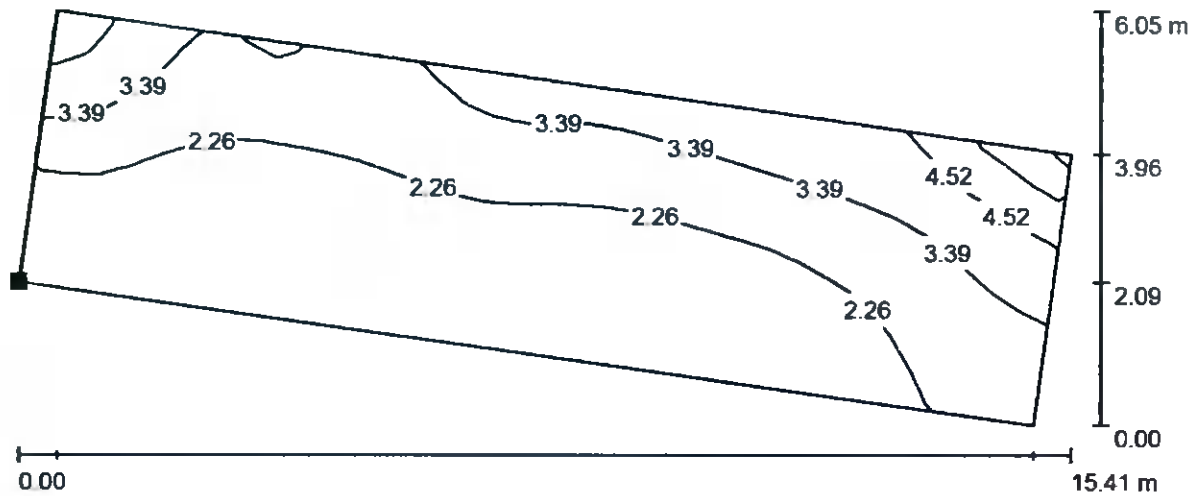

Values in Lux, Scale 1 : 111

Position of surface in external scene:
Marked point:
(270.258 m, 101.653 m, 0.000 m)



Grid: 32 x 8 Points

E_{av} [lx]
2.54

E_{min} [lx]
1.13

E_{max} [lx]
6.77

u_0
0.443

E_{min} / E_{max}
0.166

Operator
Telephone
Fax
e-Mail

Exterior Scene 1 / Typical Biodiversity Zone / Value Chart (E, Perpendicular)

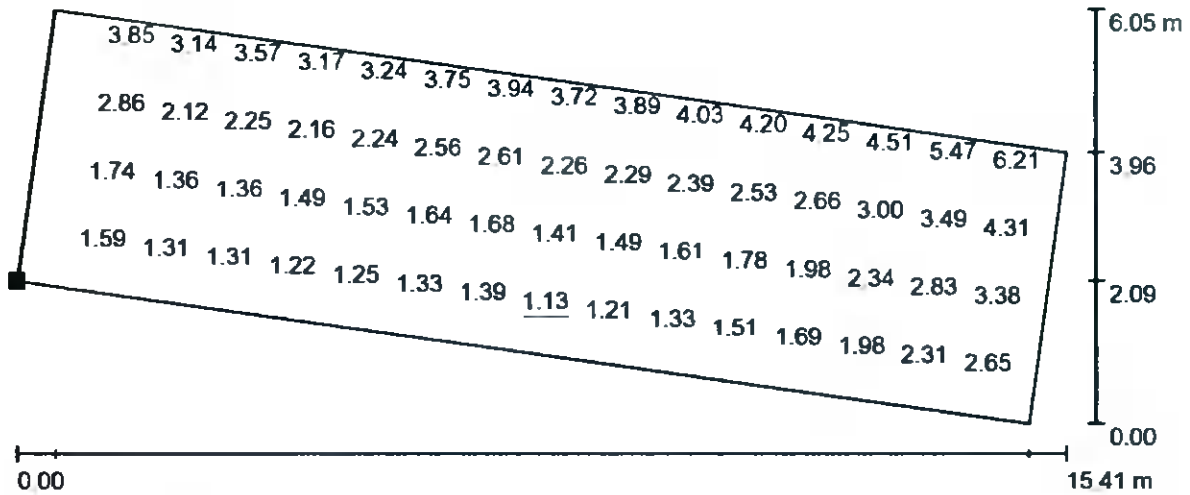

Values in Lux, Scale 1 : 111

Not all calculated values could be displayed.

Position of surface in external scene:
Marked point:
(270.258 m, 101.653 m, 0.000 m)

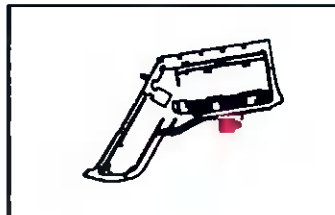

Grid: 32 x 8 Points

E_{av} [lx]
2.54

E_{min} [lx]
1.13

E_{max} [lx]
6.77

$u0$
0.443

E_{min} / E_{max}
0.166

Operator
Telephone
Fax
e-Mail

Exterior Scene 1 / Typical Biodiversity Zone / Isolines (E, Perpendicular)

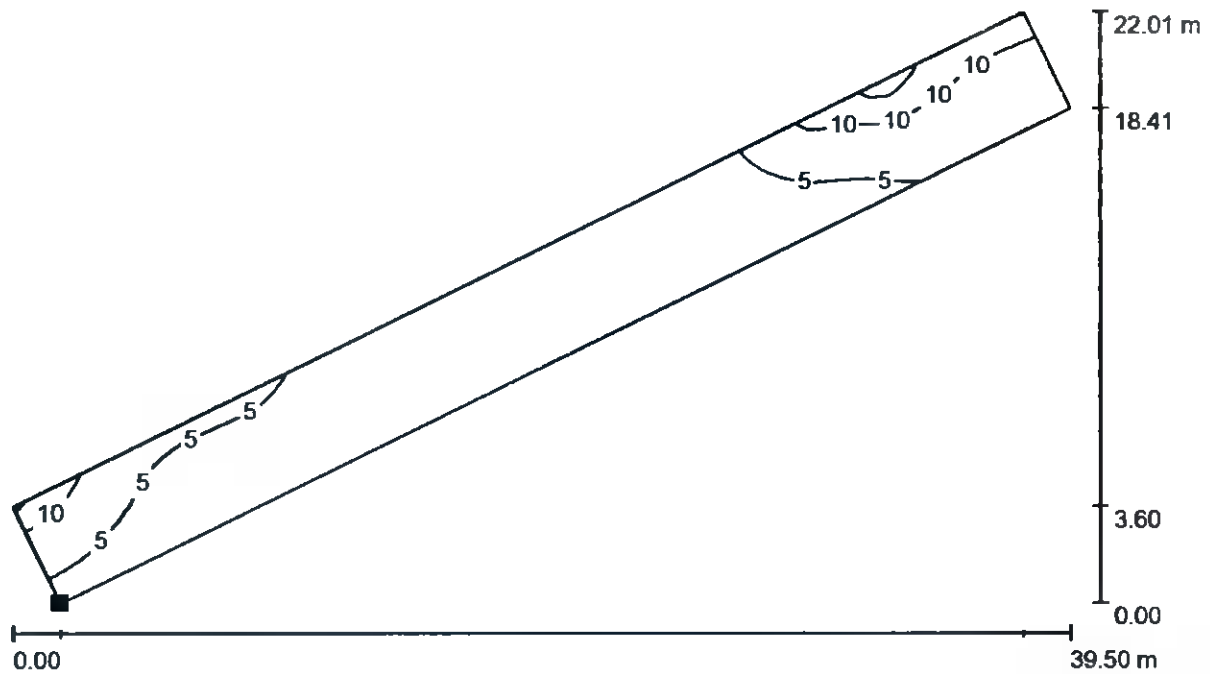

Values in Lux, Scale 1 : 283

Position of surface in external scene:
Marked point:
(293.621 m, 99.679 m, 0.000 m)

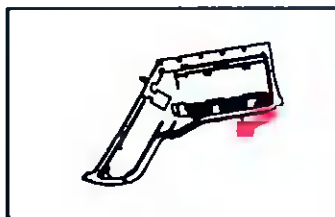

Grid: 64 x 8 Points

E_{av} [lx]
4.28

E_{min} [lx]
1.10

E_{max} [lx]
19

$u0$
0.258

E_{min} / E_{max}
0.057

Operator
Telephone
Fax
e-Mail

Exterior Scene 1 / Typical Biodiversity Zone / Value Chart (E, Perpendicular)

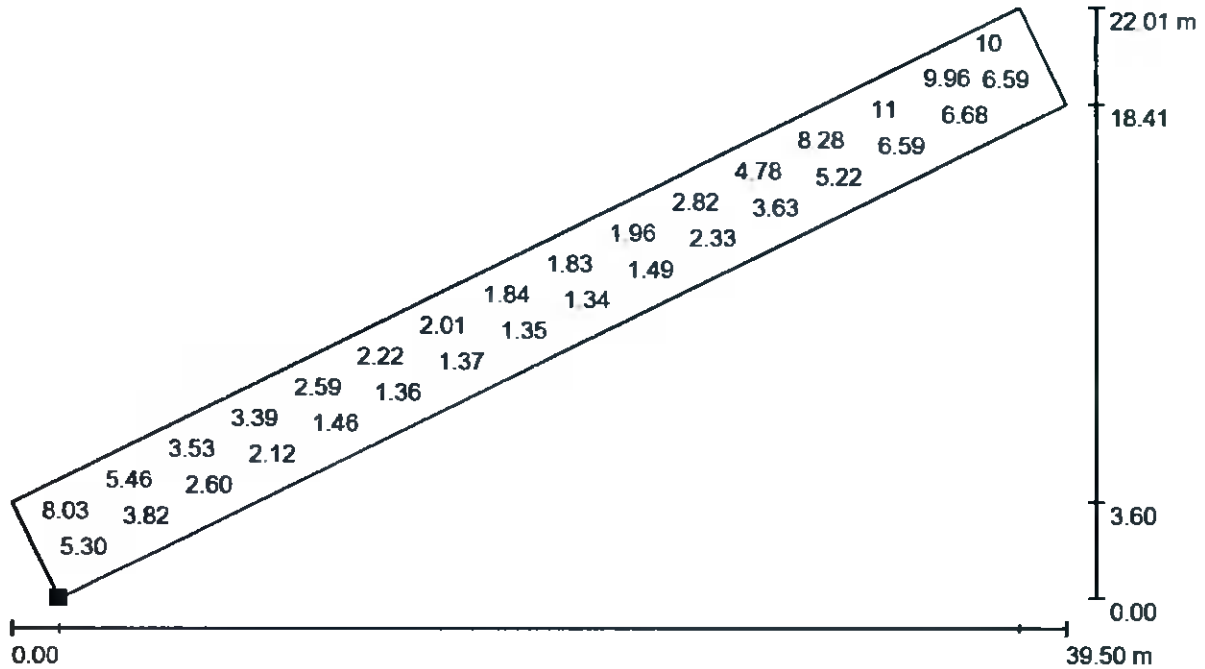

Values in Lux, Scale 1 : 283

Not all calculated values could be displayed.

Position of surface in external scene:
Marked point:
(293.621 m, 99.679 m, 0.000 m)



Grid: 64 x 8 Points

E_{av} [lx]
4.28

E_{min} [lx]
1.10

E_{max} [lx]
19

u_0
0.258

E_{min} / E_{max}
0.057

Operator
Telephone
Fax
e-Mail

Exterior Scene 1 / Typical Biodiversity Zone / Isolines (E, Perpendicular)

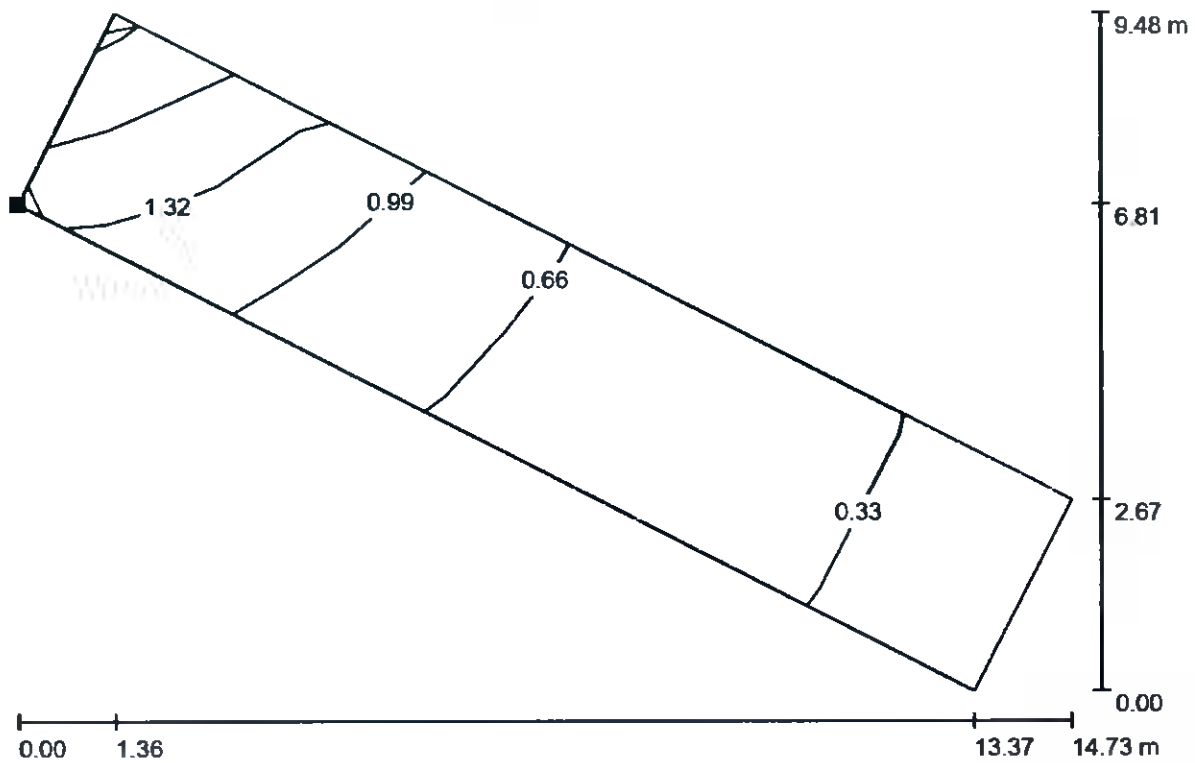

Values in Lux, Scale 1 : 106

Position of surface in external scene:

Marked point:
(204.575 m, 80.422 m, 0.000 m)



Grid: 8 x 2 Points

E_{av} [lx]
0.74

E_{min} [lx]
0.28

E_{max} [lx]
1.95

u_0
0.380

E_{min} / E_{max}
0.145

Operator
Telephone
Fax
e-Mail

Exterior Scene 1 / Typical Biodiversity Zone / Value Chart (E, Perpendicular)

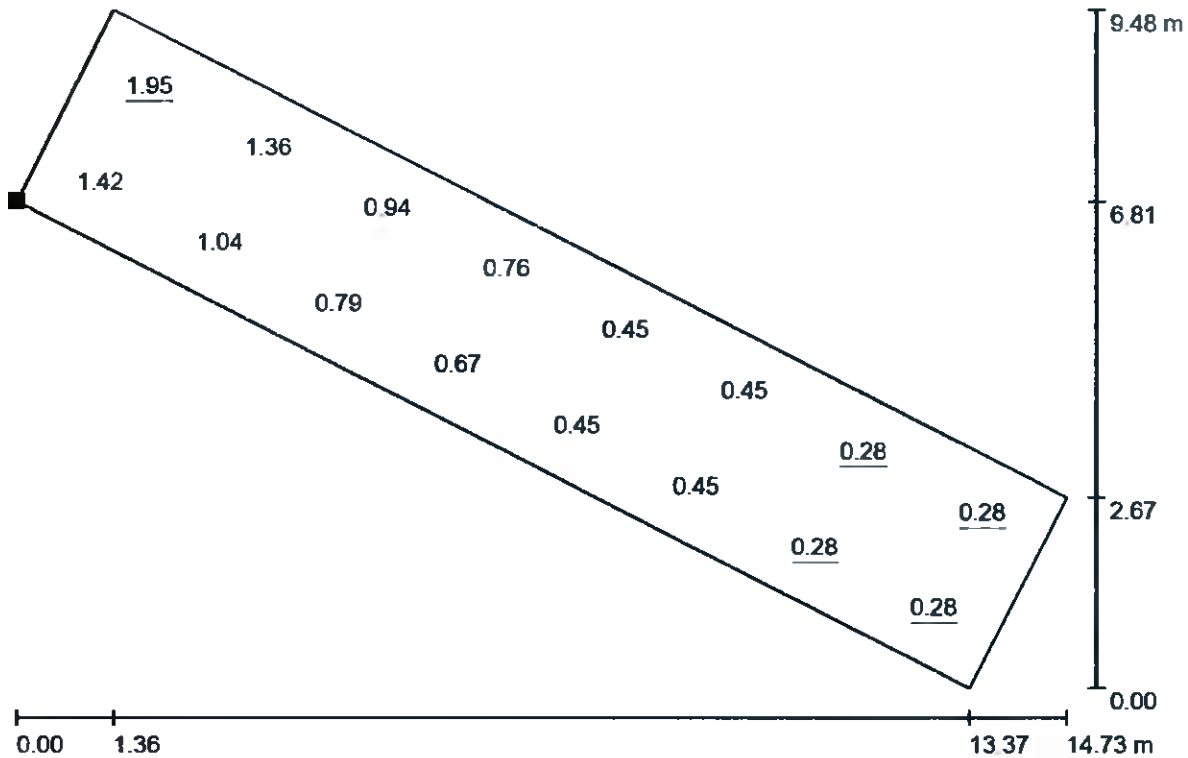

Values in Lux, Scale 1 : 106

Position of surface in external scene:
Marked point:
(204.575 m, 80.422 m, 0.000 m)

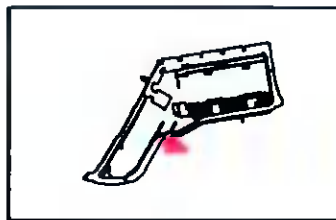

Grid: 8 x 2 Points

E_{av} [lx]	E_{min} [lx]	E_{max} [lx]	u0	E_{min} / E_{max}
0.74	0.28	1.95	0.380	0.145

Operator
Telephone
Fax
e-Mail

Exterior Scene 1 / Typical Biodiversity Zone / Isolines (E, Perpendicular)

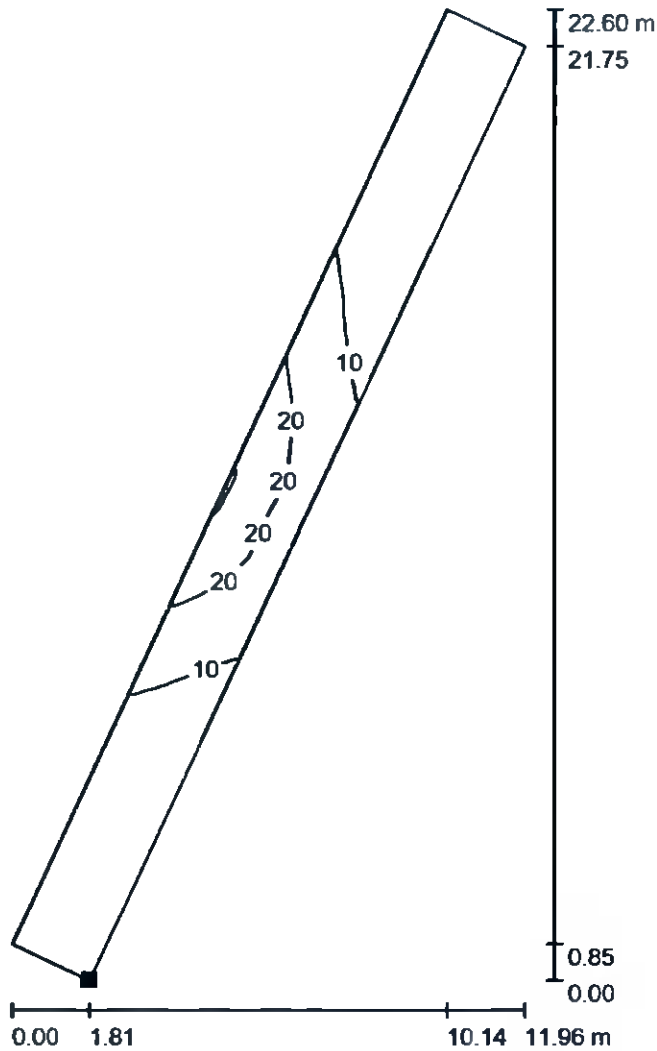

Values in Lux, Scale 1 : 177

Position of surface in external scene:
Marked point:
(174.546 m, 46.401 m, 0.000 m)



Grid: 32 x 4 Points

E_{av} [lx]
9.50

E_{min} [lx]
1.95

E_{max} [lx]
31

$u0$
0.205

E_{min} / E_{max}
0.063

Operator
Telephone
Fax
e-Mail

Exterior Scene 1 / Typical Biodiversity Zone / Value Chart (E, Perpendicular)

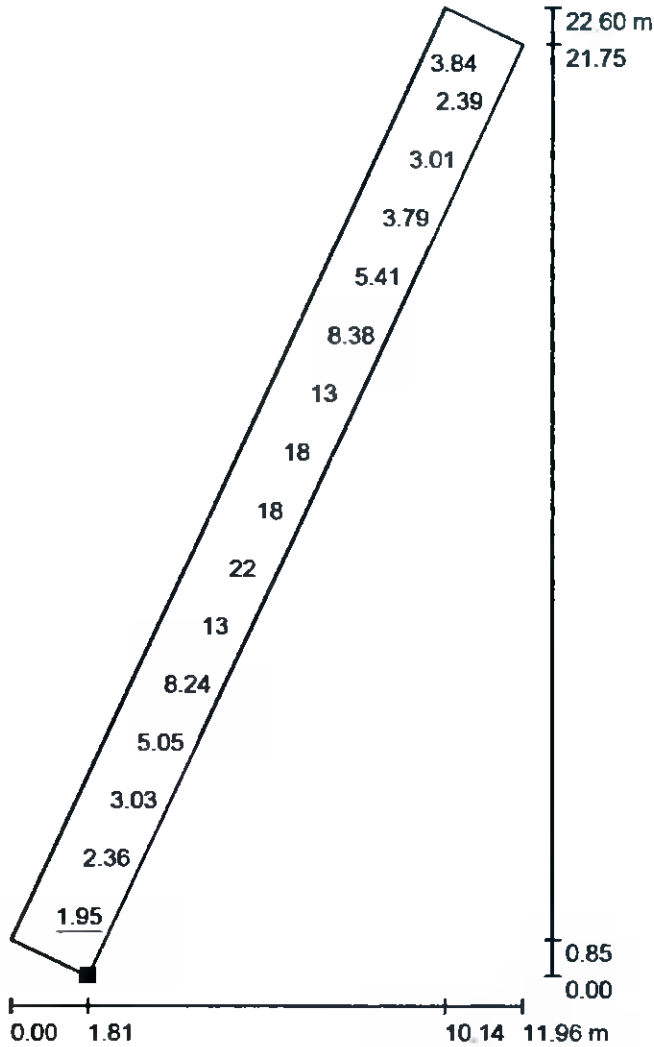

Values in Lux, Scale 1 : 177

Not all calculated values could be displayed.

Position of surface in external scene:
Marked point:
(174.546 m, 46.401 m, 0.000 m)

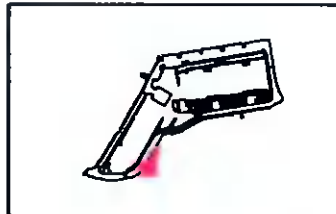

Grid: 32 x 4 Points

E_{av} [lx]	E_{min} [lx]	E_{max} [lx]	u0	E_{min} / E_{max}
9.50	1.95	31	0.205	0.063