

DUB1  
**Dialux Calculation**

PREPARED FOR



Issue for Planning

10 December 2021

Ref: DUB1-CL-XX-E003-V1-PL-BMD

# Dialux Calculation

prepared for



**Project: DUB1**  
**United Kingdom**

**Ref: DUB1-CL-XX-E003-V1-PL-BMD**

**Issue for Planning**  
**10 December 2021**

prepared by  
**Burns & McDonnell**  
**Birmingham, UK**

**COPYRIGHT © 2020 BURNS & McDONNELL EUROPE (UK) LIMITED**

## Issue History

ISSUE	DATE	COMMENTS	BY	CHECKED	APPROVED
V0	23/07/2021	Issued for Planning			
V1	10/12/2021	Issued for Planning	OH	MJ	PM

# Contents

1. Executive Summary .....	5
2. Lighting calculations .....	6

## 1. Executive Summary

These lighting calculations were prepared for the DUB1 project to demonstrate compliance with the lighting design criteria contained within the VDC OPR, VDC basis of design document and local regulations. The calculations below are for the external lighting across the site, with calculation surfaces used where required to provide accurate outputs for the different areas.

## 2. Lighting calculations

Operator  
Telephone  
Fax  
e-Mail

**Thorn 96643963 TR 72L50-740 SC BP CL2 FD W9 L60E [STD] / Luminaire Data Sheet**



Luminous emittance 1:

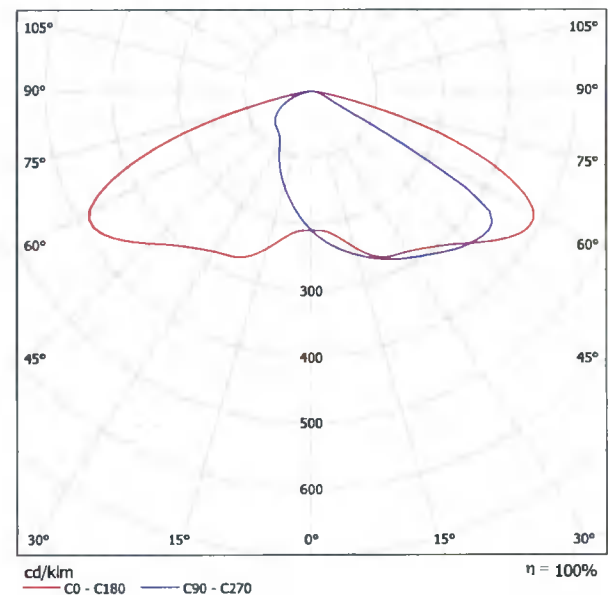

Luminaire classification according to CIE: 100  
CIE flux code: 37 77 98 100 100

Due to missing symmetry properties, no UGR table can be displayed for this luminaire.

A large size, smart urban LED lantern with 72 LEDs driven at 500mA with Street & Comfort optic and UV stabilised polycarbonate dome with anthracite finish (close to RAL7043). Class II electrical, IP66, IK08. Body, bracket and ring: die-cast aluminium (AS12U, LM6 equivalent, EN AC-44300) treated against corrosion, powder coated anthracite (close to RAL7043). Enclosure: 4mm toughened flat glass. Screws and closing set: stainless steel. Pre-wired with 9m cable. Side entry mounting to Ø60mm spigot, tilt 0°, adjustable from -15° to +10°. Equipped with power reduction circuit, effective 3 hours before and 5 hours after a calculated midnight. Complete with 4000K LED.

Dimensions: Ø577 x 155 mm  
Luminaire input power: 109 W  
Luminaire luminous flux: 15720 lm  
Luminaire efficacy: 144 lm/W  
Weight: 14.8 kg  
Scx: 0.044 m<sup>2</sup>

Operator  
Telephone  
Fax  
e-Mail

**F3 Thorn Lighting 96643963 (STD - standard) TR 72L50-740 SC BP CL2 FD W9 L60E /  
Luminaire Data Sheet**

See our luminaire catalog for an image of the luminaire.

Luminous emittance 1:

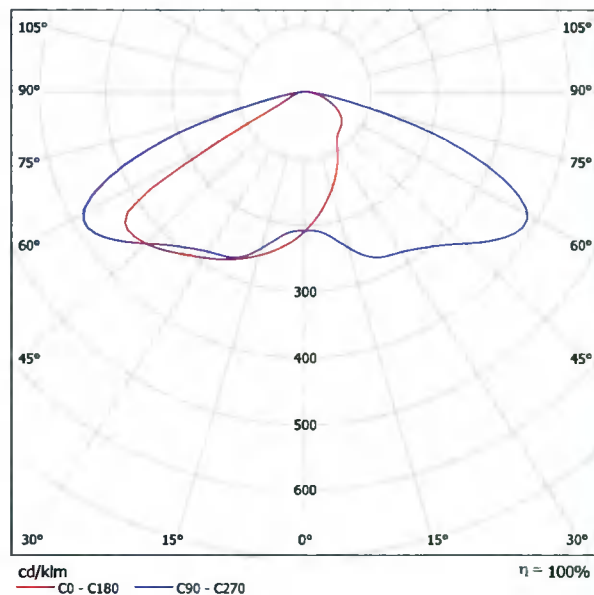

Luminaire classification according to CIE: 100  
CIE flux code: 37 77 98 100 100

Due to missing symmetry properties, no UGR table can be displayed for this luminaire.





Operator  
Telephone  
Fax  
e-Mail

**THORN Lighting 96630274 (STD - standard) THORN 4000 24L35-740 NR BPS HFX CL2  
FD T60E / Luminaire Data Sheet**

Luminous emittance 1:

See our luminaire catalog for an image of the luminaire.

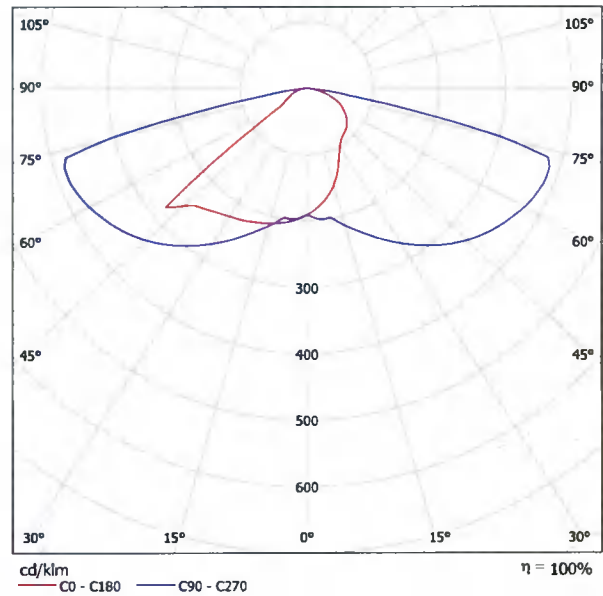

Luminaire classification according to CIE: 100  
CIE flux code: 34 73 97 100 100

Due to missing symmetry properties, no UGR table can be displayed for this luminaire.

Operator  
Telephone  
Fax  
e-Mail

**THORN Lighting 96632116 (STD - standard) THORN 24L50-740 NR BPS HFX CL1 FD T60E / Luminaire Data Sheet**

See our luminaire catalog for an image of the luminaire.

Luminous emittance 1:

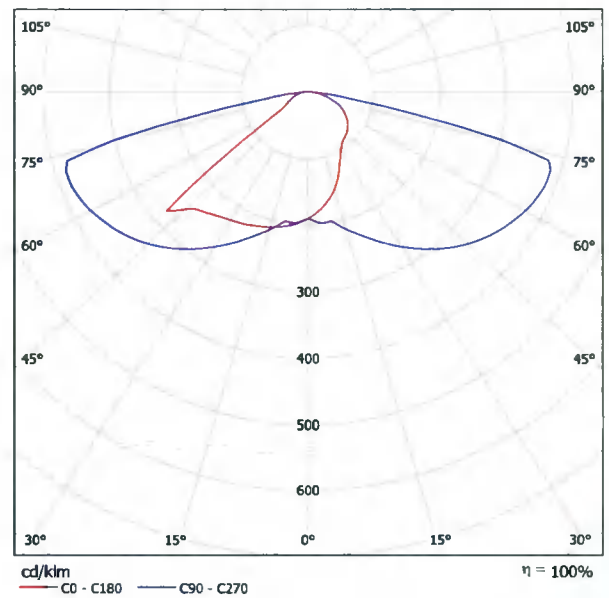

Luminaire classification according to CIE: 100  
CIE flux code: 34 73 97 100 100

Due to missing symmetry properties, no UGR table can be displayed for this luminaire.

Operator  
Telephone  
Fax  
e-Mail

**Exterior Scene 1 / Planning data**

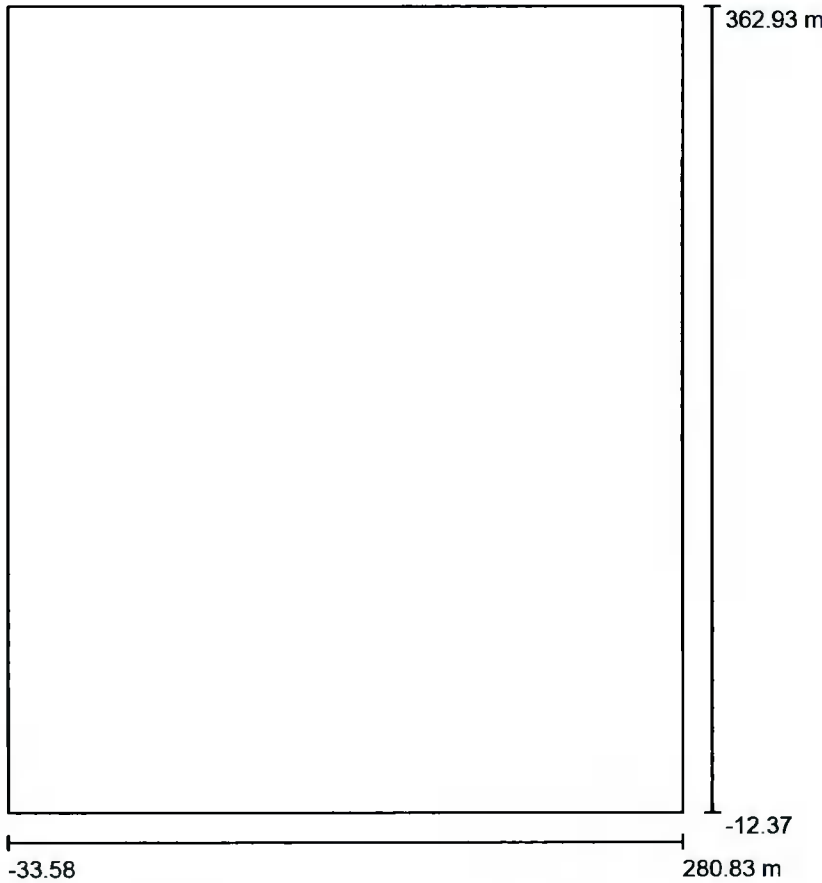

Maintenance factor: 0.80, ULR (Upward Light Ratio): 0.0%

Scale 1:3479

**Luminaire Parts List**

No.	Pieces	Designation (Correction Factor)	Φ (Luminaire) [lm]	Φ (Lamps) [lm]	P [W]
1	16	F3 Thorn Lighting 96643963 (STD - standard) TR 72L50-740 SC BP CL2 FD W9 L60E (1.000)	15718	15720	109.0
2	118	THORN Lighting 96632116 (STD - standard) THORN 24L50-740 NR BPS HFX CL1 FD T60E (1.000)	5521	5521	38.0
<b>Total:</b>			<b>902960</b>	<b>902998</b>	<b>6228.0</b>

Operator  
Telephone  
Fax  
e-Mail

**Exterior Scene 1 / Luminaire parts list**

16 Pieces F3 Thorn Lighting 96643963 (STD - standard) TR 72L50-740 SC BP CL2 FD W9 L60E  
 Article No.: 96643963 (STD - standard)  
 Luminous flux (Luminaire): 15718 lm  
 Luminous flux (Lamps): 15720 lm  
 Luminaire Wattage: 109.0 W  
 Luminaire classification according to CIE: 100  
 CIE flux code: 37 77 98 100 100  
 Fitting: 1 x THOR\_72L50SC-740 109W  
 (Correction Factor 1.000).

See our luminaire catalog for an image of the luminaire.

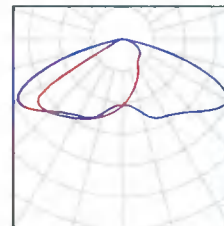

118 Pieces THORN Lighting 96632116 (STD - standard) THORN 24L50-740 NR BPS HFX CL1 FD T60E  
 Article No.: 96632116 (STD - standard)  
 Luminous flux (Luminaire): 5521 lm  
 Luminous flux (Lamps): 5521 lm  
 Luminaire Wattage: 38.0 W  
 Luminaire classification according to CIE: 100  
 CIE flux code: 34 73 97 100 100  
 Fitting: 1 x THOR\_24L50NR-740 38W  
 (Correction Factor 1.000).

See our luminaire catalog for an image of the luminaire.

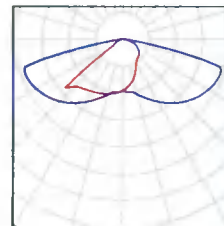

Operator  
Telephone  
Fax  
e-Mail

Exterior Scene 1 / Ground Element 1 / Surface 1 / Isolines (E)

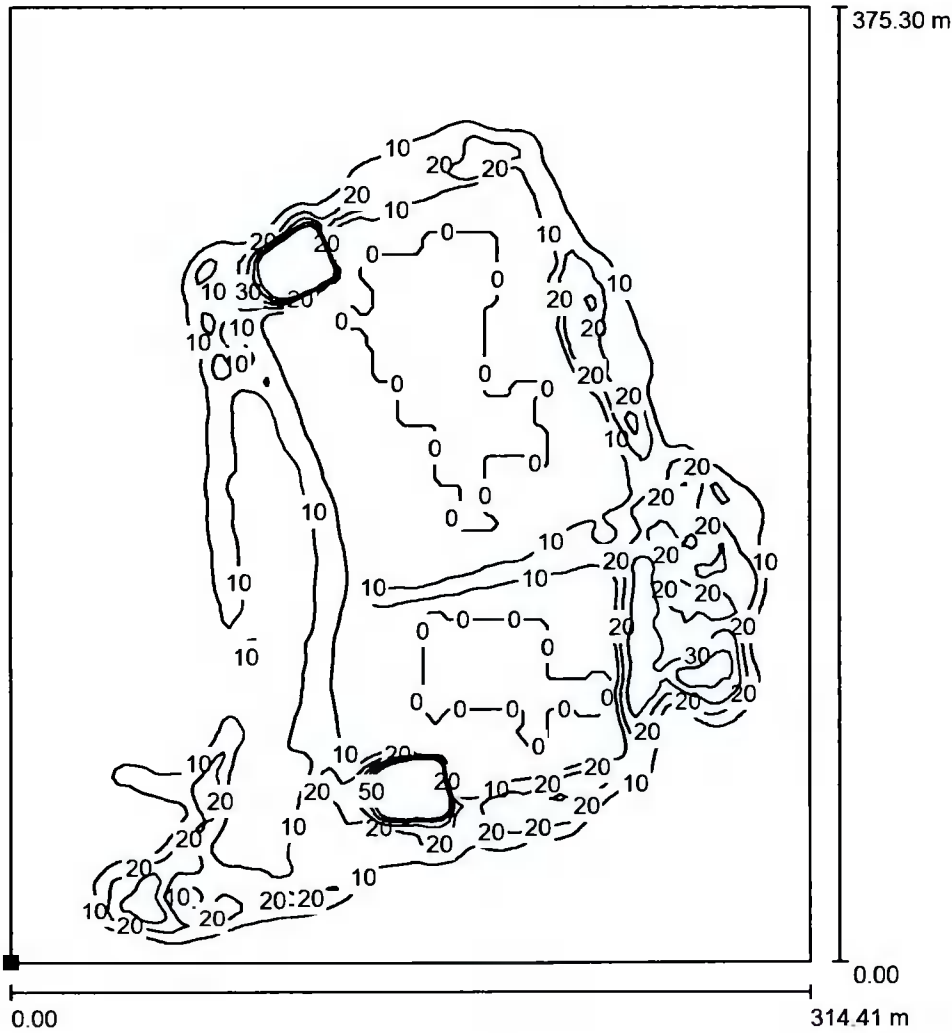

Values in Lux, Scale 1 : 2935

Position of surface in external scene:  
Marked point:  
(-33.584 m, -12.375 m, 0.000 m)

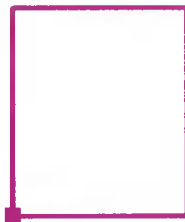

Grid: 128 x 128 Points

$E_{av}$  [lx]  
5.40

$E_{min}$  [lx]  
0.00

$E_{max}$  [lx]  
168

$u_0$   
0.000

$E_{min} / E_{max}$   
0.000

Operator  
Telephone  
Fax  
e-Mail

**Exterior Scene 1 / AREA 2 - PLAN EAST PARKING / Isolines (E, Perpendicular)**

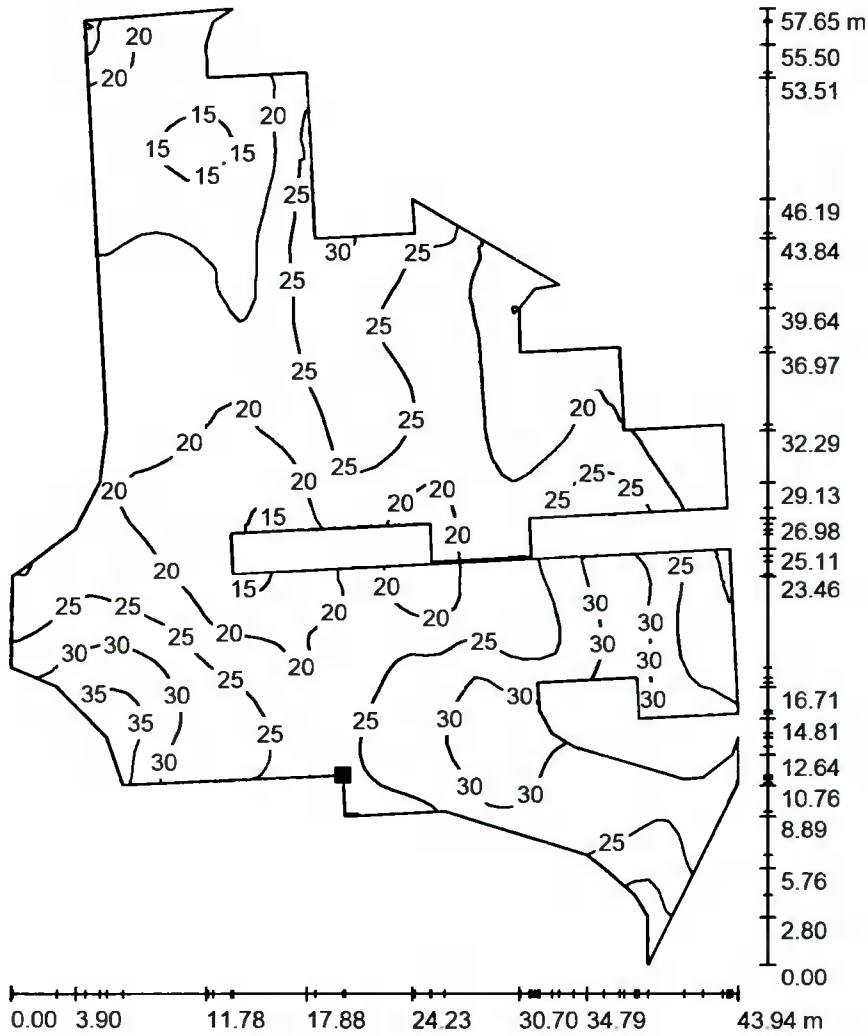

Values in Lux, Scale 1 : 451

Position of surface in external scene:  
Marked point:  
(229.294 m, 139.726 m, 0.000 m)

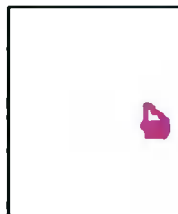

Grid: 700 x 700 Points

$E_{av}$  [lx]  
23

$E_{min}$  [lx]  
14

$E_{max}$  [lx]  
37

$u_0$   
0.590

$E_{min} / E_{max}$   
0.364

Operator  
Telephone  
Fax  
e-Mail

Exterior Scene 1 / AREA 3 - PLAN SOUTHEAST CIRCLE / Isolines (E, Perpendicular)

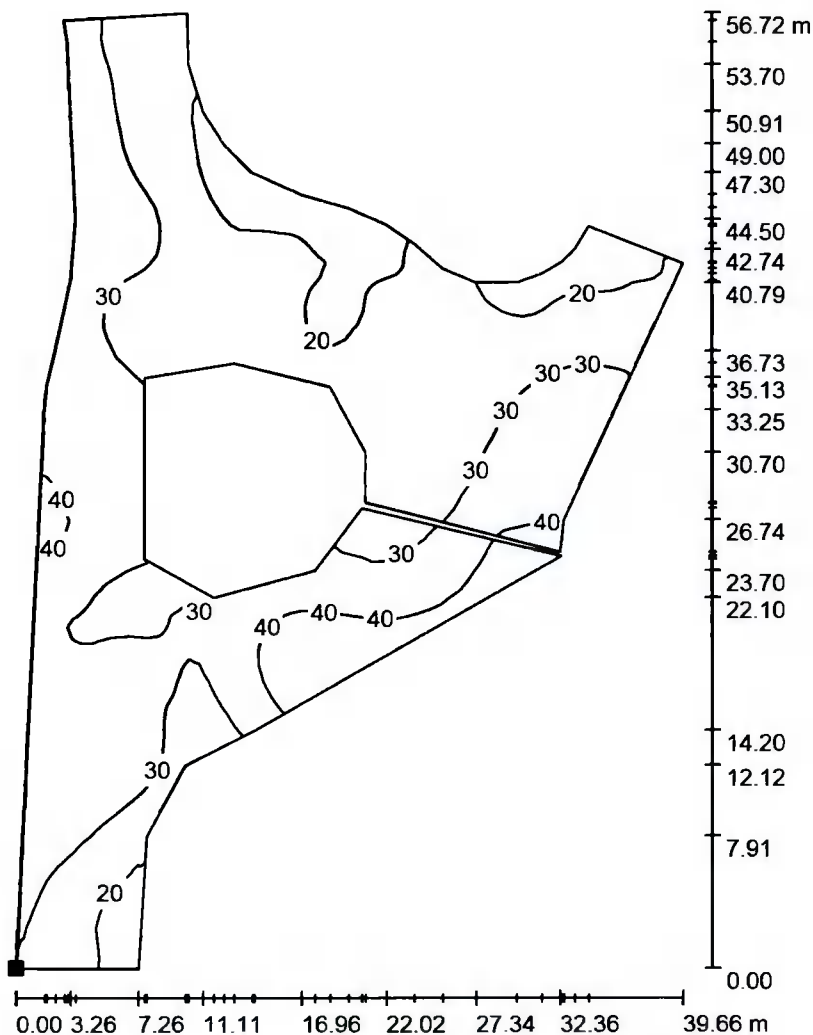

Values in Lux, Scale 1 : 444

Position of surface in external scene:  
Marked point:  
(213.139 m, 82.700 m, 0.000 m)

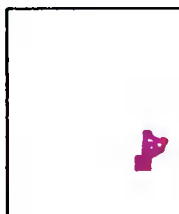

Grid: 600 x 600 Points

$E_{av}$  [lx]  
29

$E_{min}$  [lx]  
14

$E_{max}$  [lx]  
47

$u_0$   
0.487

$E_{min} / E_{max}$   
0.300



Operator  
Telephone  
Fax  
e-Mail

Exterior Scene 1 / AREA 4 - CENTRAL BUILDING PARKING / Isolines (E, Perpendicular)

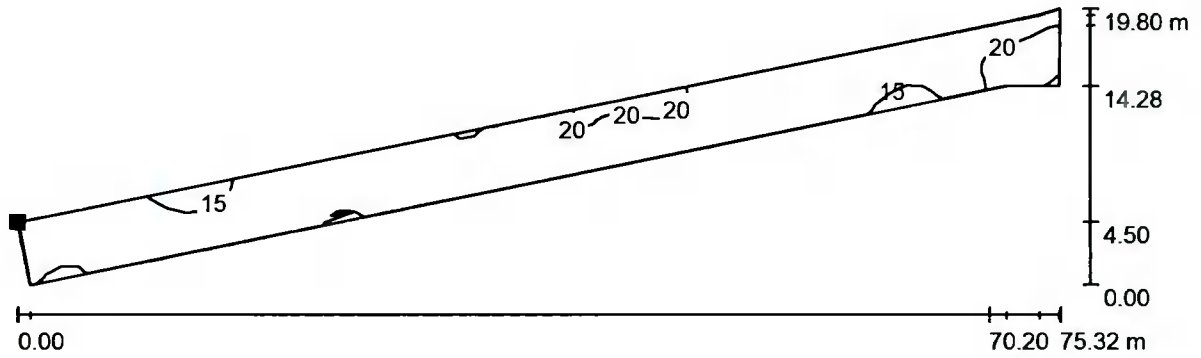

Values in Lux, Scale 1 : 539

Position of surface in external scene:  
Marked point:  
(134.000 m, 136.500 m, 0.000 m)

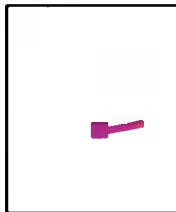

Grid: 500 x 500 Points

$E_{av}$ [lx]	$E_{min}$ [lx]	$E_{max}$ [lx]	u0	$E_{min} / E_{max}$
17	13	26	0.774	0.526



Operator  
Telephone  
Fax  
e-Mail

**Exterior Scene 1 / AREA 5 - PLAN WEST TO NORTH SECTION / Isolines (E, Perpendicular)**

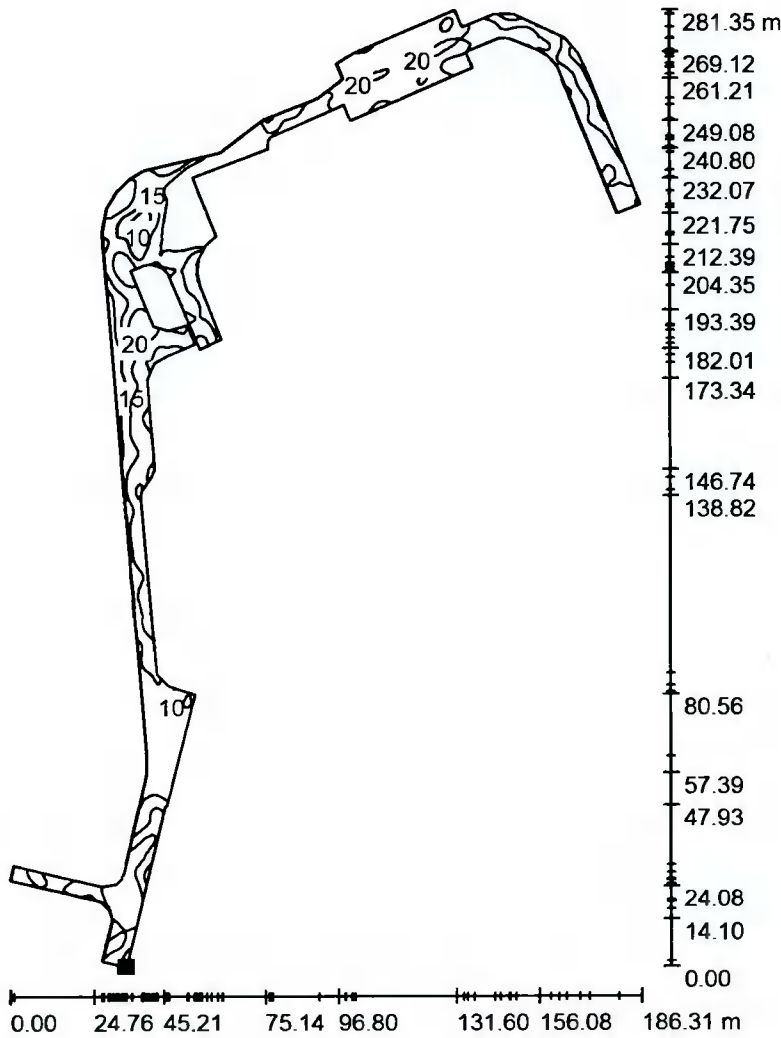

Values in Lux, Scale 1 : 2201

Position of surface in external scene:  
Marked point:  
(44.441 m, 33.547 m, 0.000 m)

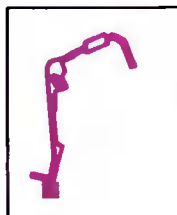

Grid: 700 x 700 Points

$E_{av}$  [lx]  
18

$E_{min}$  [lx]  
1.98

$E_{max}$  [lx]  
107

$u_0$   
0.109

$E_{min} / E_{max}$   
0.019

Operator  
Telephone  
Fax  
e-Mail

**Exterior Scene 1 / AREA 6 - LOADING BAY SECTION / Isolines (E, Perpendicular)**

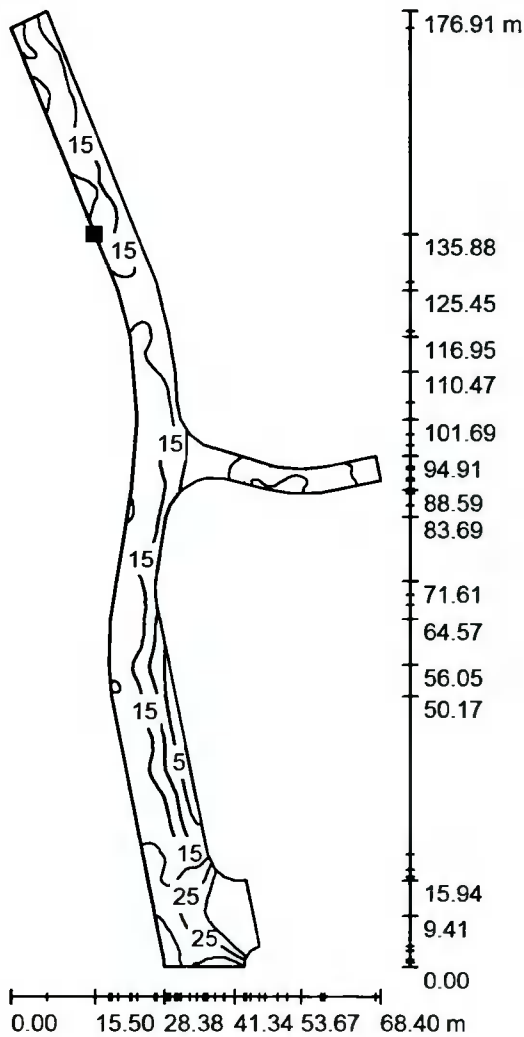

Values in Lux, Scale 1 : 1384

Position of surface in external scene:  
Marked point:  
(81.900 m, 177.468 m, 0.000 m)

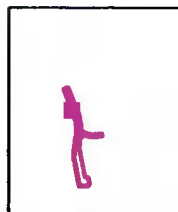

Grid: 700 x 700 Points

$E_{av}$  [lx]  
17

$E_{min}$  [lx]  
1.94

$E_{max}$  [lx]  
61

$u_0$   
0.116

$E_{min} / E_{max}$   
0.032

Operator  
Telephone  
Fax  
e-Mail

**Exterior Scene 1 / AREA 7 - PLAN UPPER LOADING BAY / Isolines (E, Perpendicular)**

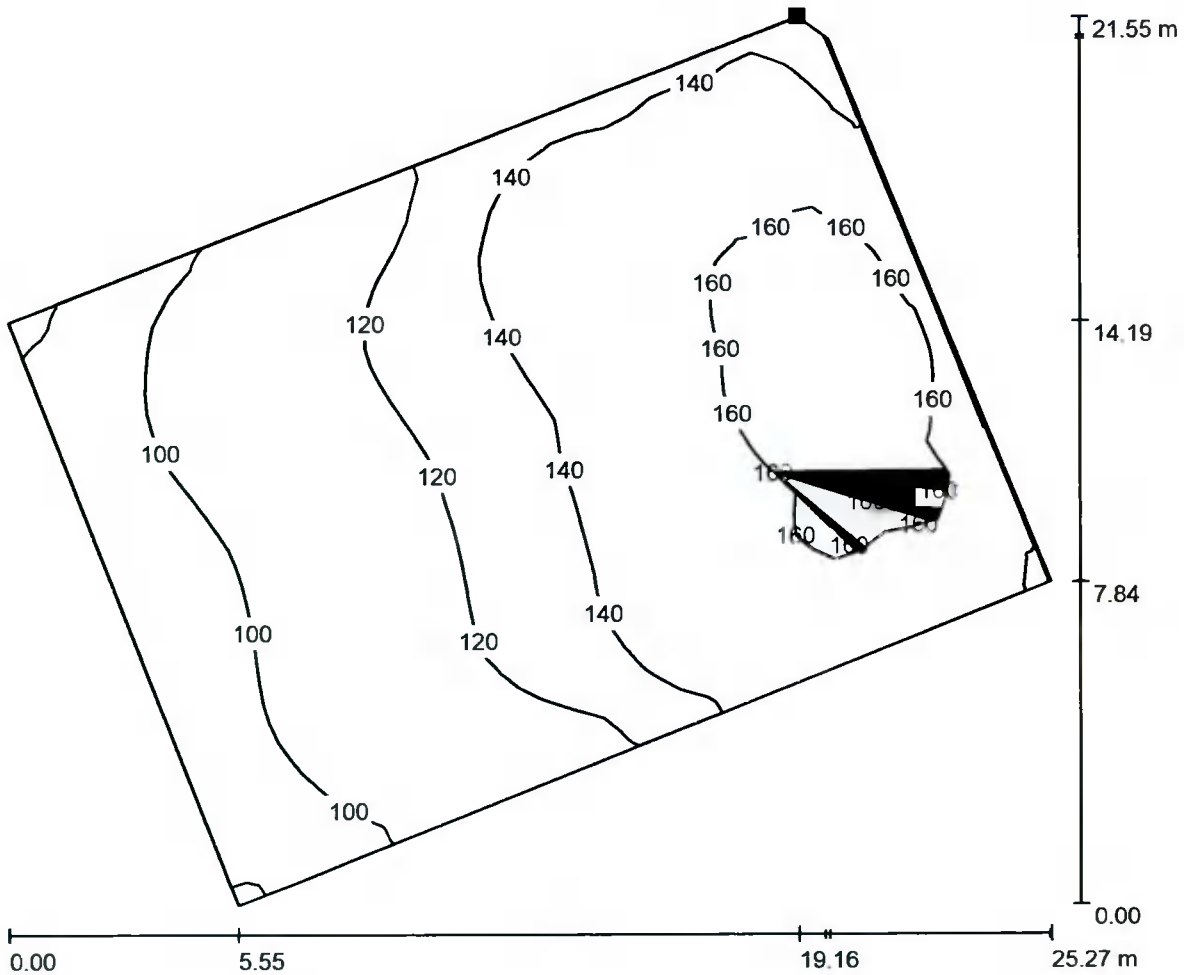

Values in Lux, Scale 1 : 181

Position of surface in external scene:  
Marked point:  
(87.487 m, 272.832 m, 0.000 m)



Grid: 700 x 700 Points

$E_{av}$  [lx]  
130

$E_{min}$  [lx]  
77

$E_{max}$  [lx]  
172

$u_0$   
0.592

$E_{min} / E_{max}$   
0.448



Operator  
Telephone  
Fax  
e-Mail

Exterior Scene 1 / AREA 8 - PLAN LOWER LOADING BAY / Isolines (E, Perpendicular)

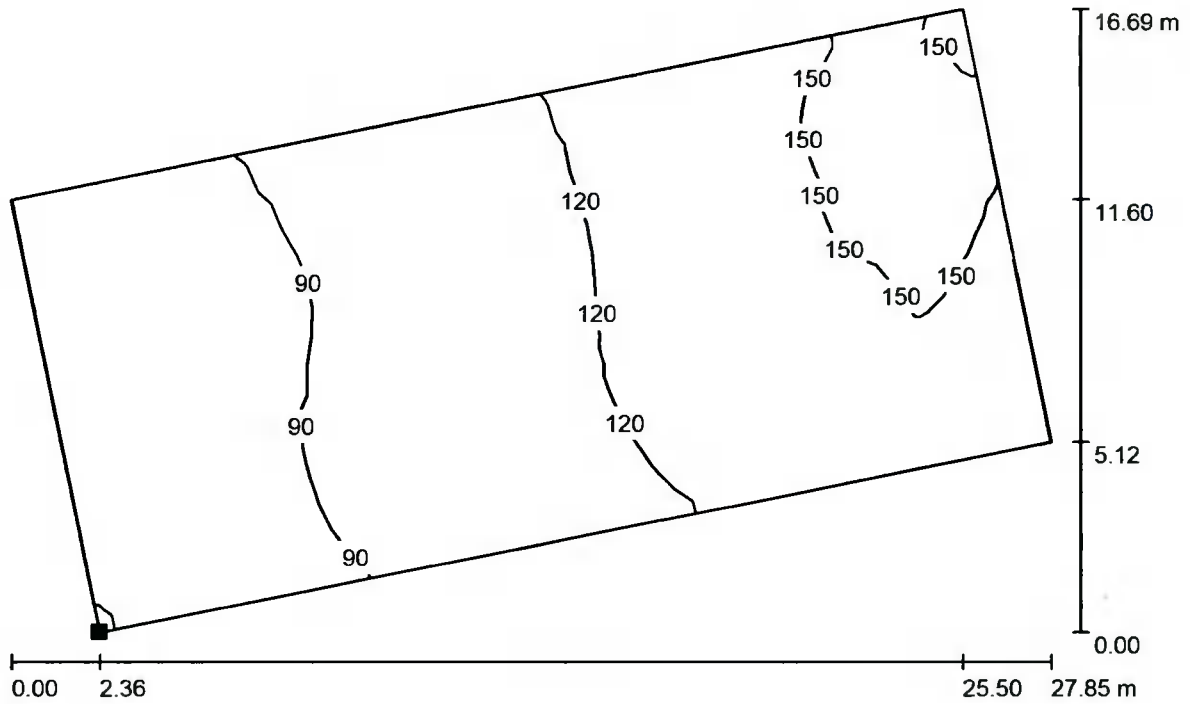

Values in Lux, Scale 1 : 200

Position of surface in external scene:  
Marked point:  
(112.240 m, 46.026 m, 0.000 m)

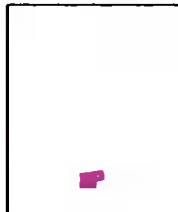

Grid: 700 x 700 Points

$E_{av}$  [lx]  
112

$E_{min}$  [lx]  
59

$E_{max}$  [lx]  
162

$u_0$   
0.525

$E_{min} / E_{max}$   
0.361



Operator  
Telephone  
Fax  
e-Mail

**Exterior Scene 1 / AREA 11 - PLAN SOUTH STREET / Isolines (E, Perpendicular)**

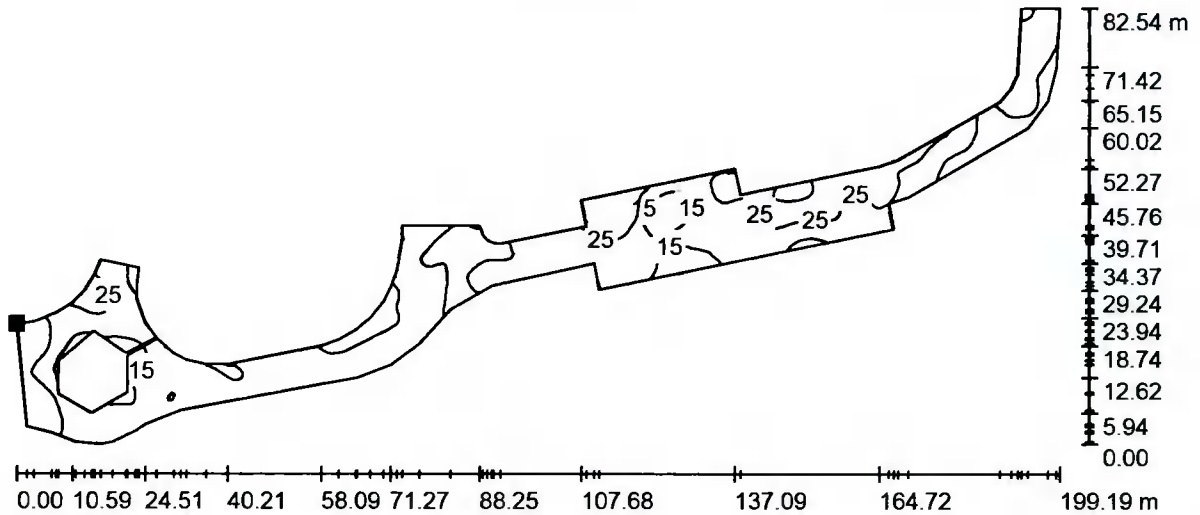

Values in Lux, Scale 1 : 1425

Position of surface in external scene:  
Marked point:  
(21.209 m, 22.869 m, 0.000 m)



Grid: 700 x 700 Points

$E_{av}$  [lx]  
20

$E_{min}$  [lx]  
4.78

$E_{max}$  [lx]  
81

$u_0$   
0.237

$E_{min} / E_{max}$   
0.059

Operator  
Telephone  
Fax  
e-Mail

**Exterior Scene 1 / AREA 12 - PLAN WEST BAT TRESPASS / Isolines (E, Perpendicular)**

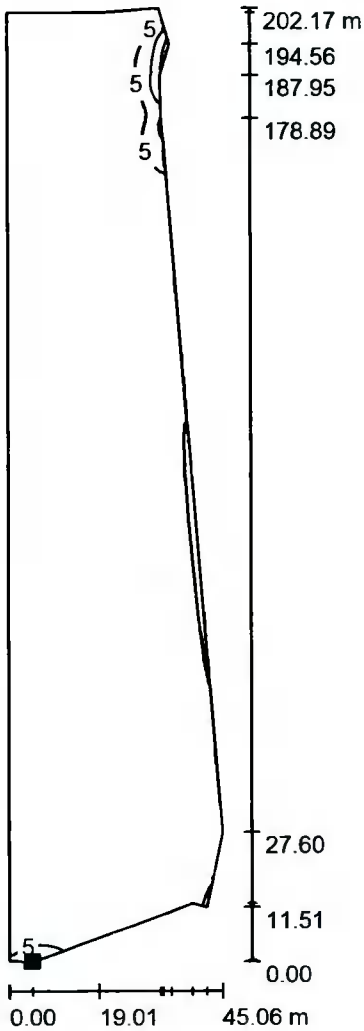

Values in Lux, Scale 1 : 1581

Position of surface in external scene:  
Marked point:  
(8.804 m, 65.013 m, 0.000 m)



Grid: 600 x 600 Points

$E_{av}$  [lx]  
0.68

$E_{min}$  [lx]  
0.02

$E_{max}$  [lx]  
17

$u0$   
0.023

$E_{min} / E_{max}$   
0.001



Operator  
Telephone  
Fax  
e-Mail

Exterior Scene 1 / AREA 13 - PLAN NORTH TO EAST LIGHT TRESPASS / Isolines (E, Perpendicular)

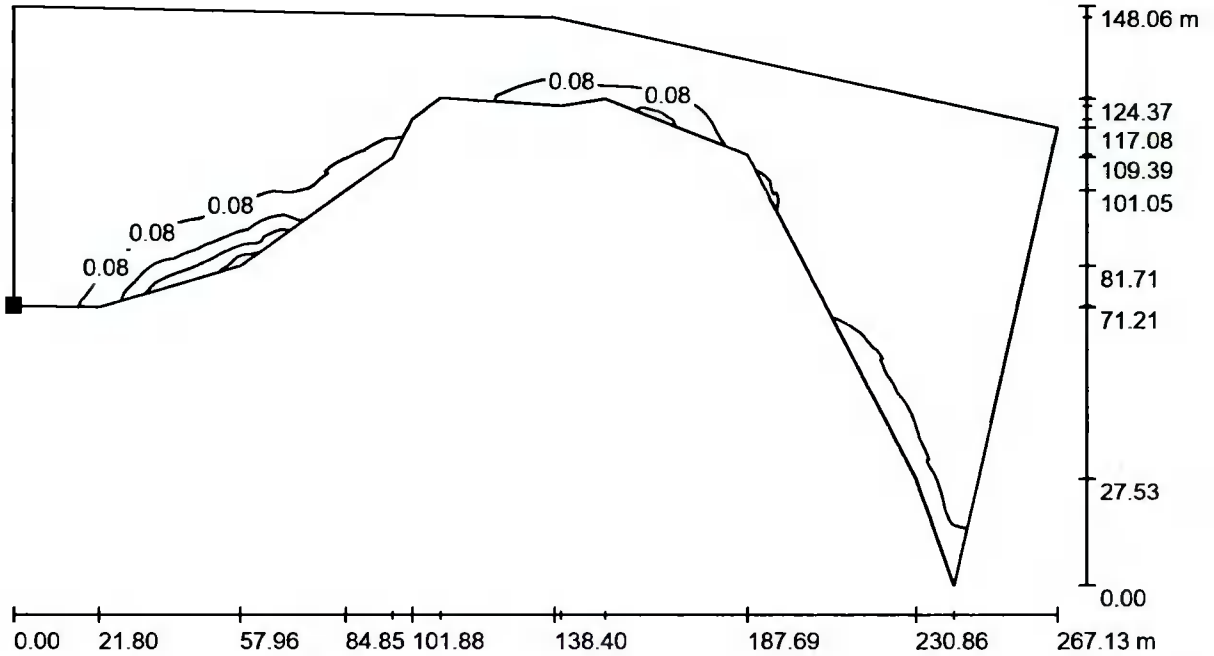

Values in Lux, Scale 1 : 1910

Position of surface in external scene:

Marked point:

(5.300 m, 286.400 m, 0.000 m)

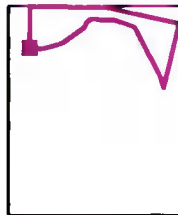

Grid: 700 x 700 Points

$E_{av}$  [lx]  
0.03

$E_{min}$  [lx]  
0.00

$E_{max}$  [lx]  
0.41

u0  
0.045

$E_{min} / E_{max}$   
0.004



Operator  
Telephone  
Fax  
e-Mail

**Exterior Scene 1 / AREA 14 - WALKWAY NORTH / Isolines (E, Perpendicular)**

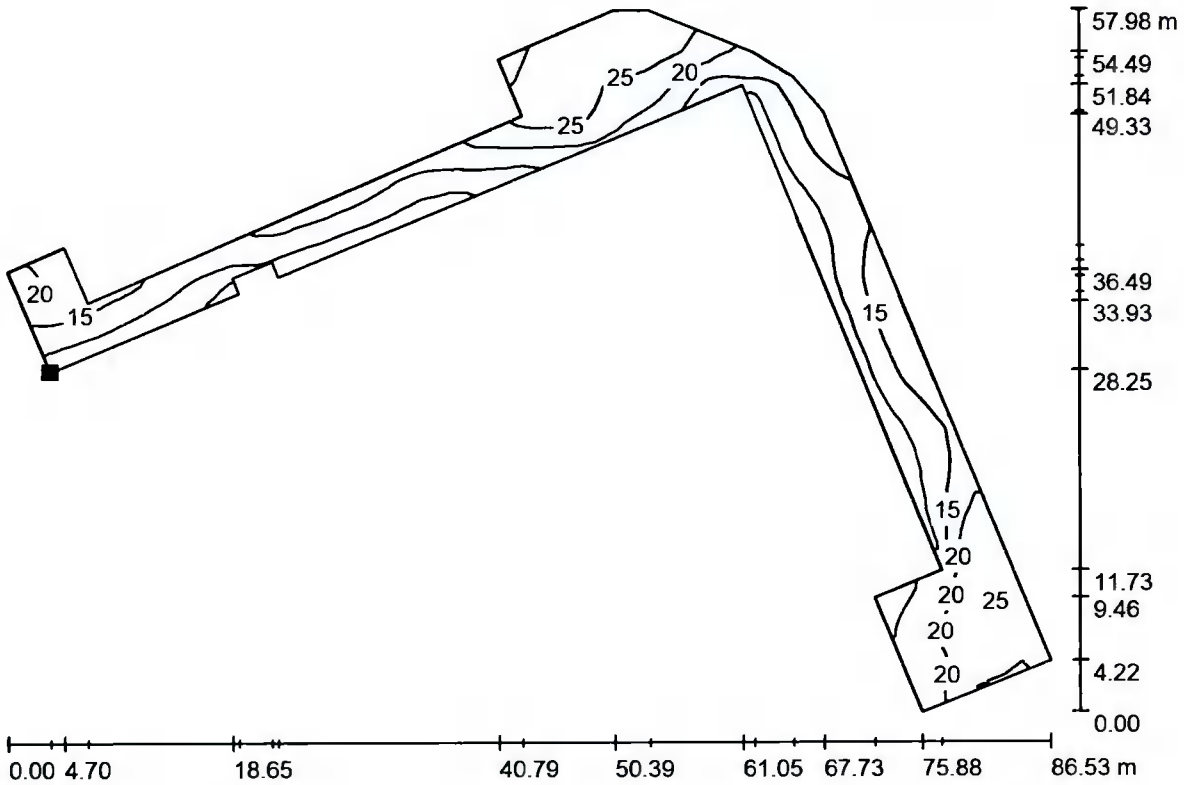

Values in Lux, Scale 1 : 619

Position of surface in external scene:  
Marked point:  
(107.867 m, 276.949 m, 0.000 m)

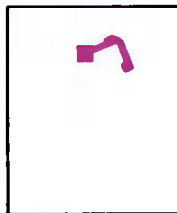

Grid: 700 x 700 Points

$E_{av}$  [lx]  
17

$E_{min}$  [lx]  
2.29

$E_{max}$  [lx]  
30

$u_0$   
0.135

$E_{min} / E_{max}$   
0.077

Operator  
Telephone  
Fax  
e-Mail

**Exterior Scene 1 / AREA 15 WALKWAY NORTH-EAST / Isolines (E, Perpendicular)**

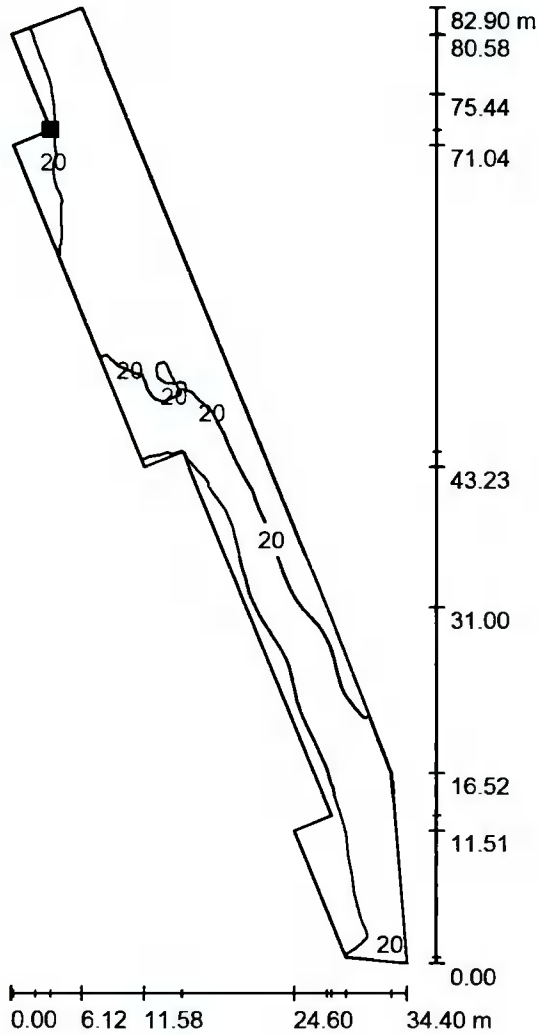

Values in Lux, Scale 1 : 649

Position of surface in external scene:  
Marked point:  
(183.557 m, 240.496 m, 0.000 m)



Grid: 700 x 700 Points

$E_{av}$  [lx]  
19

$E_{min}$  [lx]  
3.31

$E_{max}$  [lx]  
30

$u_0$   
0.176

$E_{min} / E_{max}$   
0.109

Operator  
Telephone  
Fax  
e-Mail

**Exterior Scene 1 / AREA 16 USEABLE AREA CENTRE / Isolines (E, Perpendicular)**

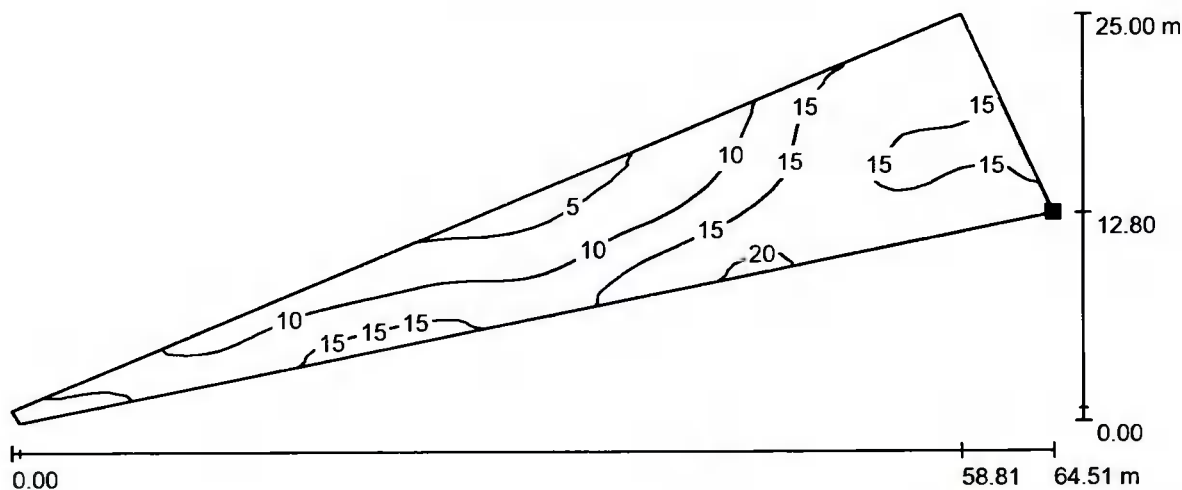

Values in Lux, Scale 1 : 462

Position of surface in external scene:  
Marked point:  
(198.400 m, 149.500 m, 0.000 m)



Grid: 700 x 700 Points

$E_{av}$ [lx]	$E_{min}$ [lx]	$E_{max}$ [lx]	u0	$E_{min} / E_{max}$
13	3.63	21	0.277	0.175

Operator  
Telephone  
Fax  
e-Mail

Exterior Scene 1 / AREA 17 WALKWAY SOUTH-EAST / Isolines (E, Perpendicular)

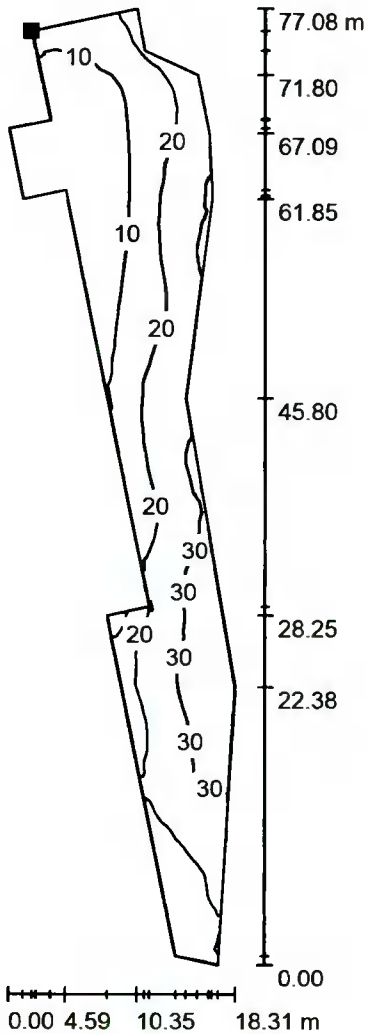

Values in Lux, Scale 1 : 603

Position of surface in external scene:  
Marked point:  
(196.900 m, 144.500 m, 0.000 m)



Grid: 700 x 700 Points

$E_{av}$ [lx]	$E_{min}$ [lx]	$E_{max}$ [lx]	u0	$E_{min} / E_{max}$
19	0.89	39	0.047	0.023

Operator  
Telephone  
Fax  
e-Mail

**Exterior Scene 1 / AREA 18 WALKWAY SOUTH / Isolines (E, Perpendicular)**

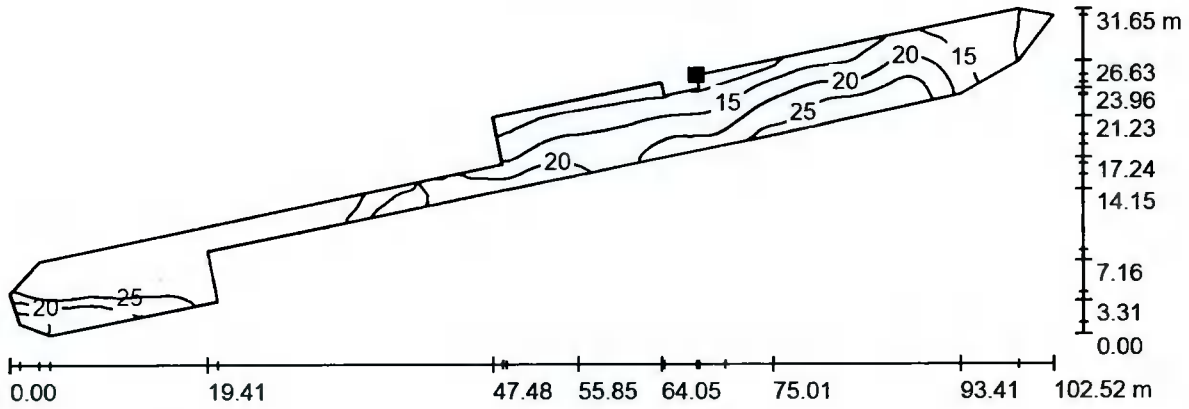

Values in Lux, Scale 1 : 733

Position of surface in external scene:

Marked point:  
(176.982 m, 63.429 m, 0.000 m)



Grid: 700 x 700 Points

$E_{av}$  [lx]  
27

$E_{min}$  [lx]  
5.30

$E_{max}$  [lx]  
116

$u_0$   
0.199

$E_{min} / E_{max}$   
0.046



Operator  
Telephone  
Fax  
e-Mail

Exterior Scene 1 / AREA 19 WALKWAY GPP SOUTH / Isolines (E, Perpendicular)

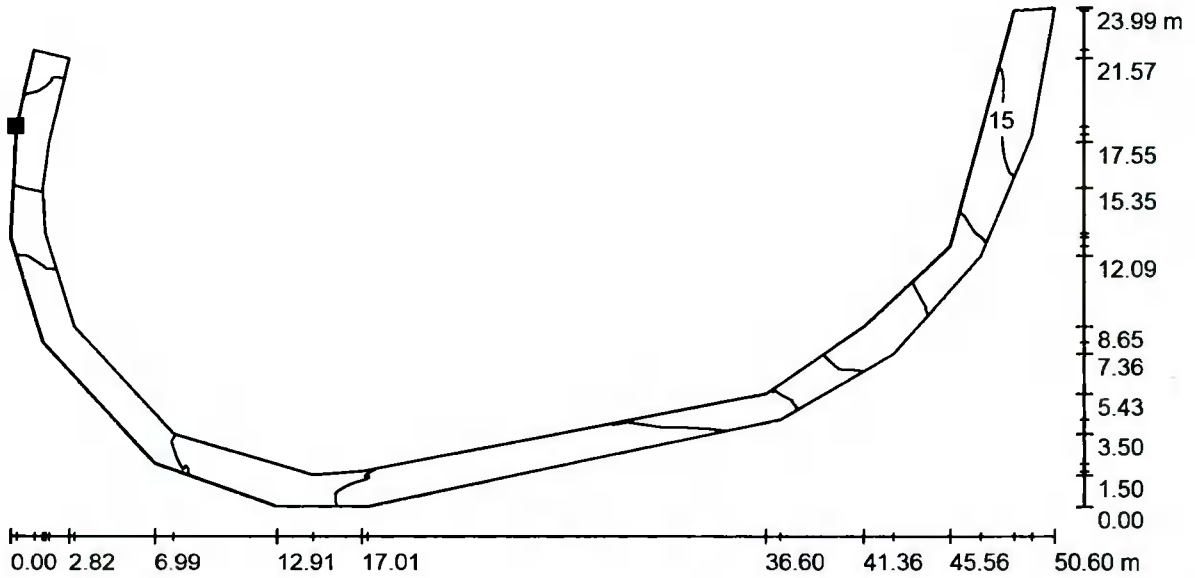

Values in Lux, Scale 1 : 362

Position of surface in external scene:  
Marked point:  
(44.441 m, 33.547 m, 0.000 m)



Grid: 700 x 700 Points

$E_{av}$ [lx]	$E_{min}$ [lx]	$E_{max}$ [lx]	u0	$E_{min} / E_{max}$
13	3.31	20	0.248	0.168

Operator  
Telephone  
Fax  
e-Mail

Exterior Scene 1 / AREA 20 WALKWAY GPP NORTH / Isolines (E, Perpendicular)

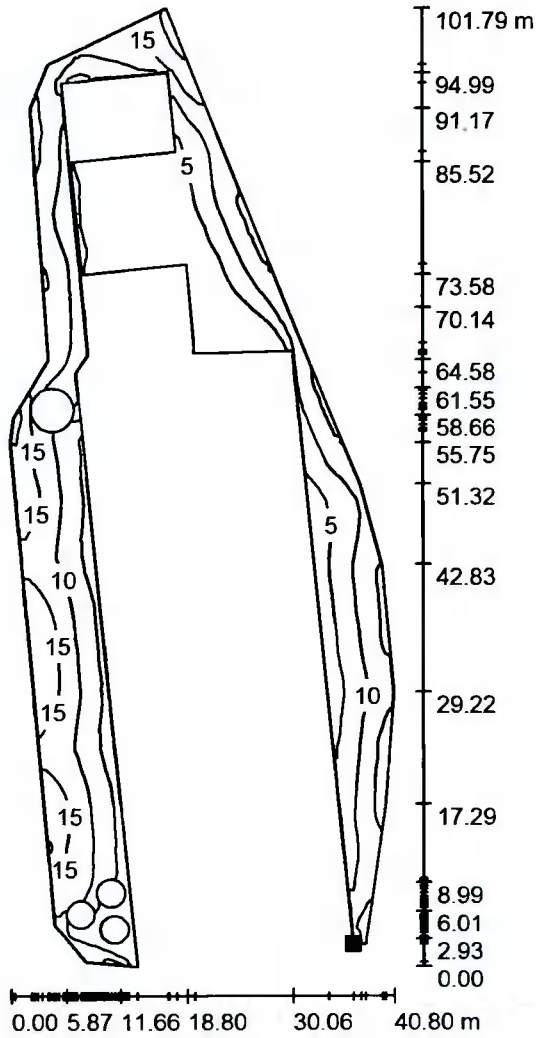

Values in Lux, Scale 1 : 796

Position of surface in external scene:  
Marked point:  
(85.344 m, 118.044 m, 0.000 m)



Grid: 700 x 700 Points

$E_{av}$  [lx]  
9.11

$E_{min}$  [lx]  
0.26

$E_{max}$  [lx]  
22

$u_0$   
0.028

$E_{min} / E_{max}$   
0.012



Operator  
Telephone  
Fax  
e-Mail

Exterior Scene 1 / AREA 21 WALKWAY ENTRANCE SOUTH WEST 1 / Isolines (E, Perpendicular)

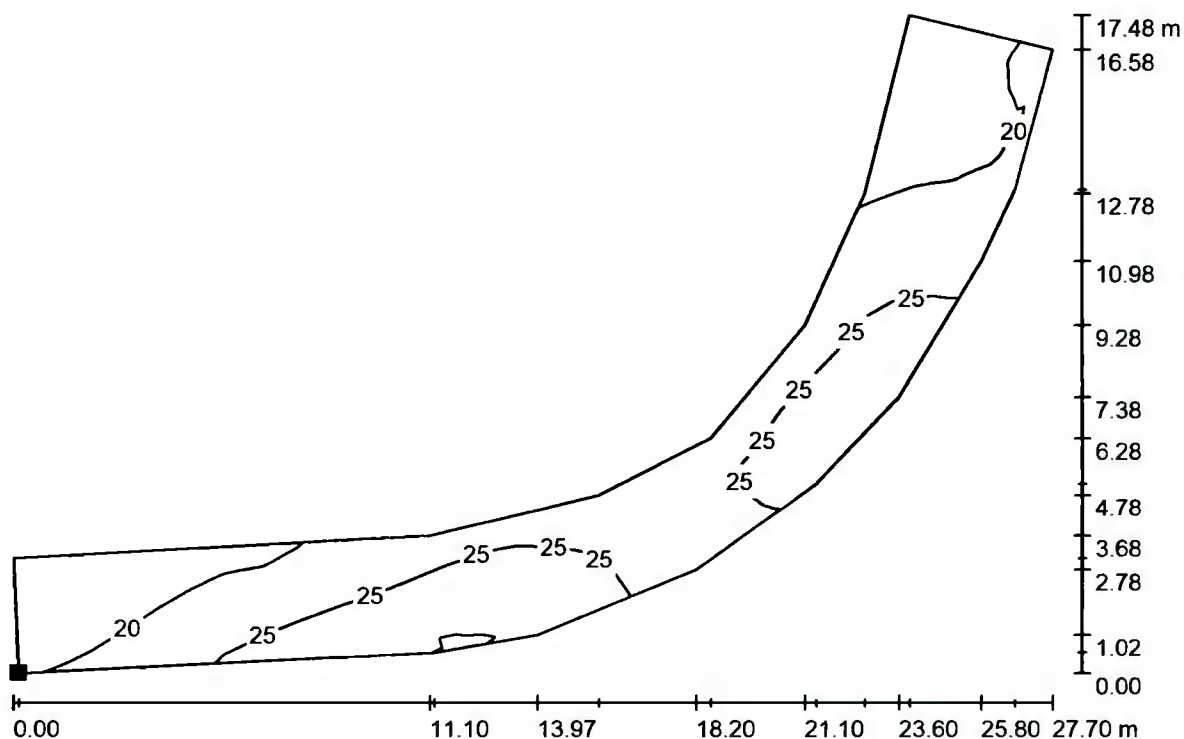

Values in Lux, Scale 1 : 199

Position of surface in external scene:

Marked point:  
(10.640 m, 22.320 m, 0.000 m)



Grid: 700 x 700 Points

$E_{av}$  [lx]  
23

$E_{min}$  [lx]  
16

$E_{max}$  [lx]  
31

$u_0$   
0.702

$E_{min} / E_{max}$   
0.523



Operator  
Telephone  
Fax  
e-Mail

**Exterior Scene 1 / AREA 22 WALKWAY ENTRANCE SOUTH WEST 2 / Isolines (E, Perpendicular)**

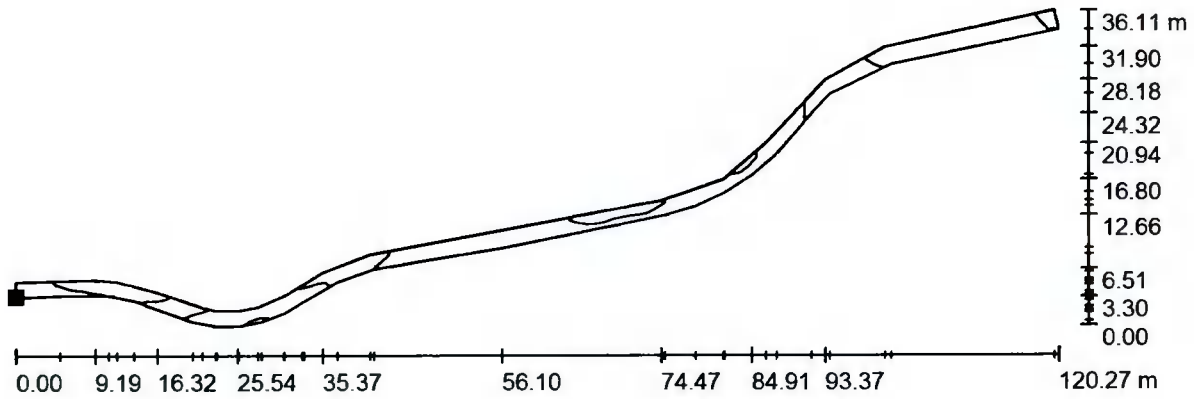

Values in Lux, Scale 1 : 860

Position of surface in external scene:  
Marked point:  
(11.581 m, 1.620 m, 0.000 m)



Grid: 700 x 700 Points

$E_{av}$  [lx]  
19

$E_{min}$  [lx]  
11

$E_{max}$  [lx]  
31

$u_0$   
0.586

$E_{min} / E_{max}$   
0.361



Operator  
Telephone  
Fax  
e-Mail

Exterior Scene 1 / AREA 23 WALKWAY EAST PARKING / Isolines (E, Perpendicular)

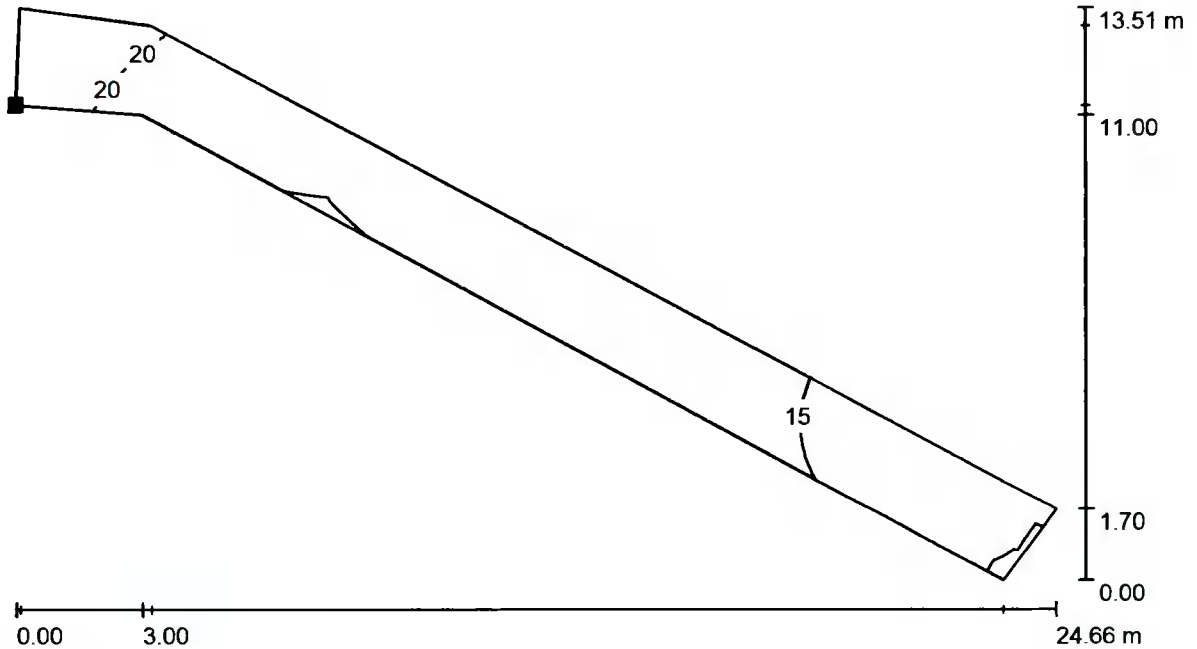

Values in Lux, Scale 1 : 177

Position of surface in external scene:

Marked point:  
(223.200 m, 137.128 m, 0.000 m)

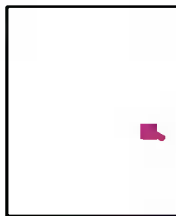

Grid: 700 x 700 Points

$E_{av}$  [lx]  
16

$E_{min}$  [lx]  
13

$E_{max}$  [lx]  
25

u0  
0.766

$E_{min} / E_{max}$   
0.509

Operator  
Telephone  
Fax  
e-Mail

**Exterior Scene 1 / AREA 24 WALKWAY ENTRANCE EAST / Isolines (E, Perpendicular)**

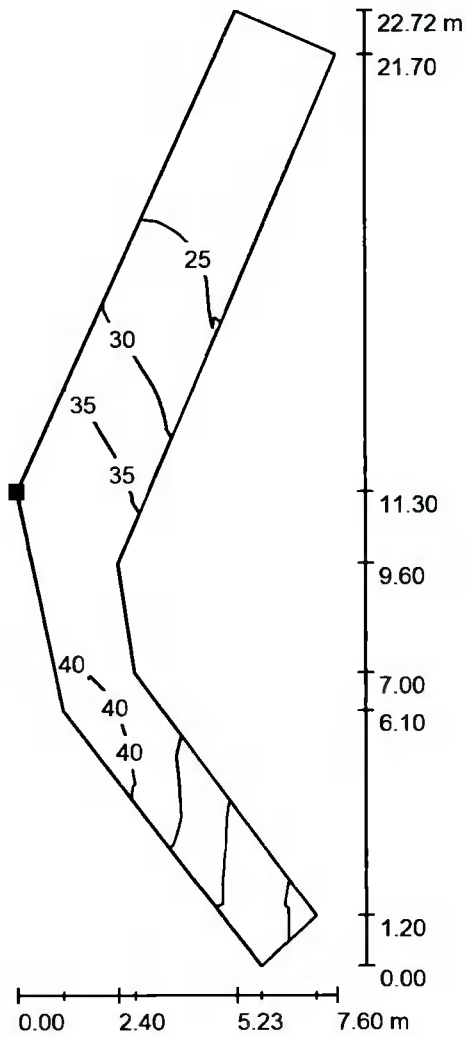

Values in Lux, Scale 1 : 178

Position of surface in external scene:  
Marked point:  
(247.600 m, 113.800 m, 0.000 m)



Grid: 700 x 700 Points

$E_{av}$  [lx]  
30

$E_{min}$  [lx]  
20

$E_{max}$  [lx]  
42

$u0$   
0.654

$E_{min} / E_{max}$   
0.476



Operator  
Telephone  
Fax  
e-Mail

Exterior Scene 1 / AREA 25 ROAD ENTRANCE SOUTH WEST / Isolines (E, Perpendicular)

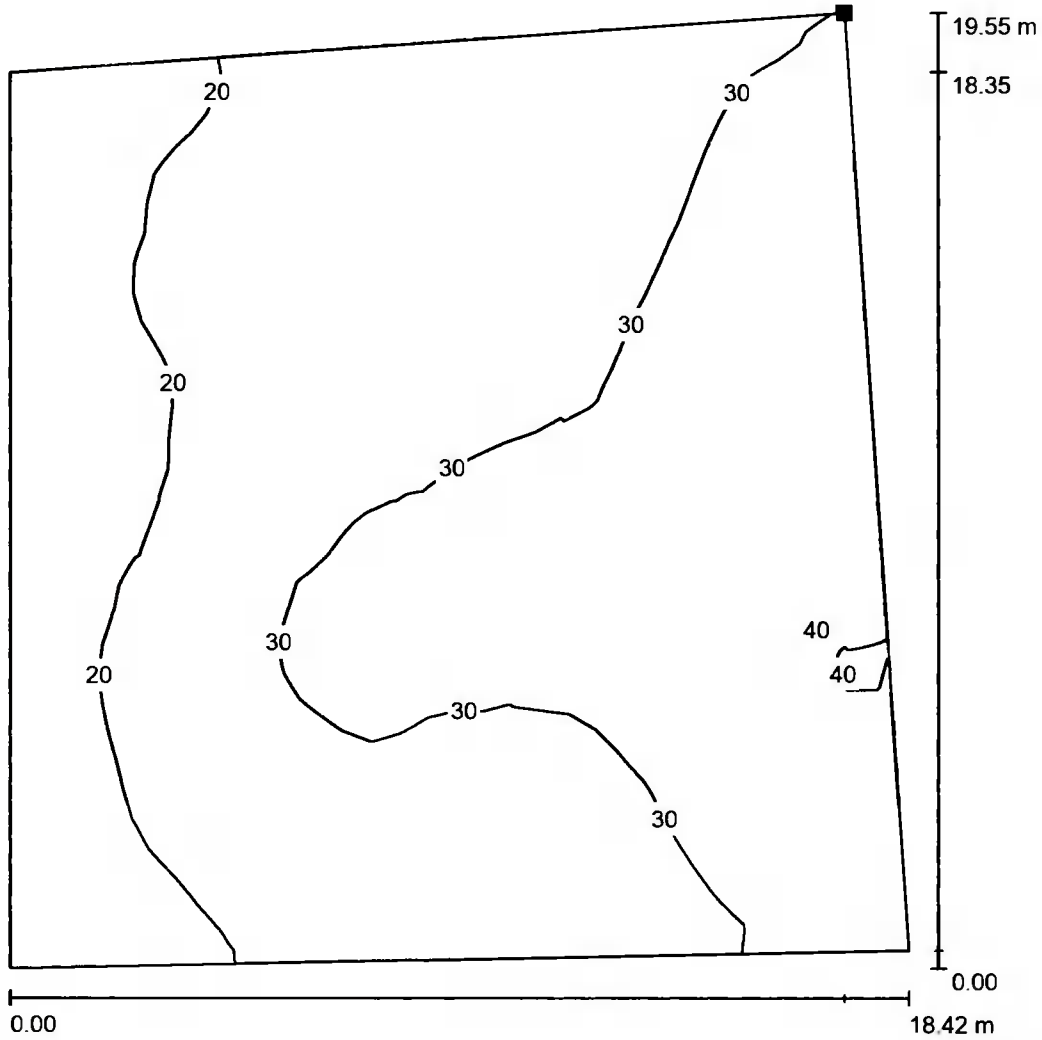

Values in Lux, Scale 1 : 153

Position of surface in external scene:  
Marked point:  
(19.400 m, 22.800 m, 0.000 m)



Grid: 700 x 700 Points

$E_{av}$  [lx]  
27

$E_{min}$  [lx]  
13

$E_{max}$  [lx]  
41

$u_0$   
0.497

$E_{min} / E_{max}$   
0.328

Operator  
Telephone  
Fax  
e-Mail

**Exterior Scene 1 / AREA 26 ROAD ENTRANCE EAST / Isolines (E, Perpendicular)**

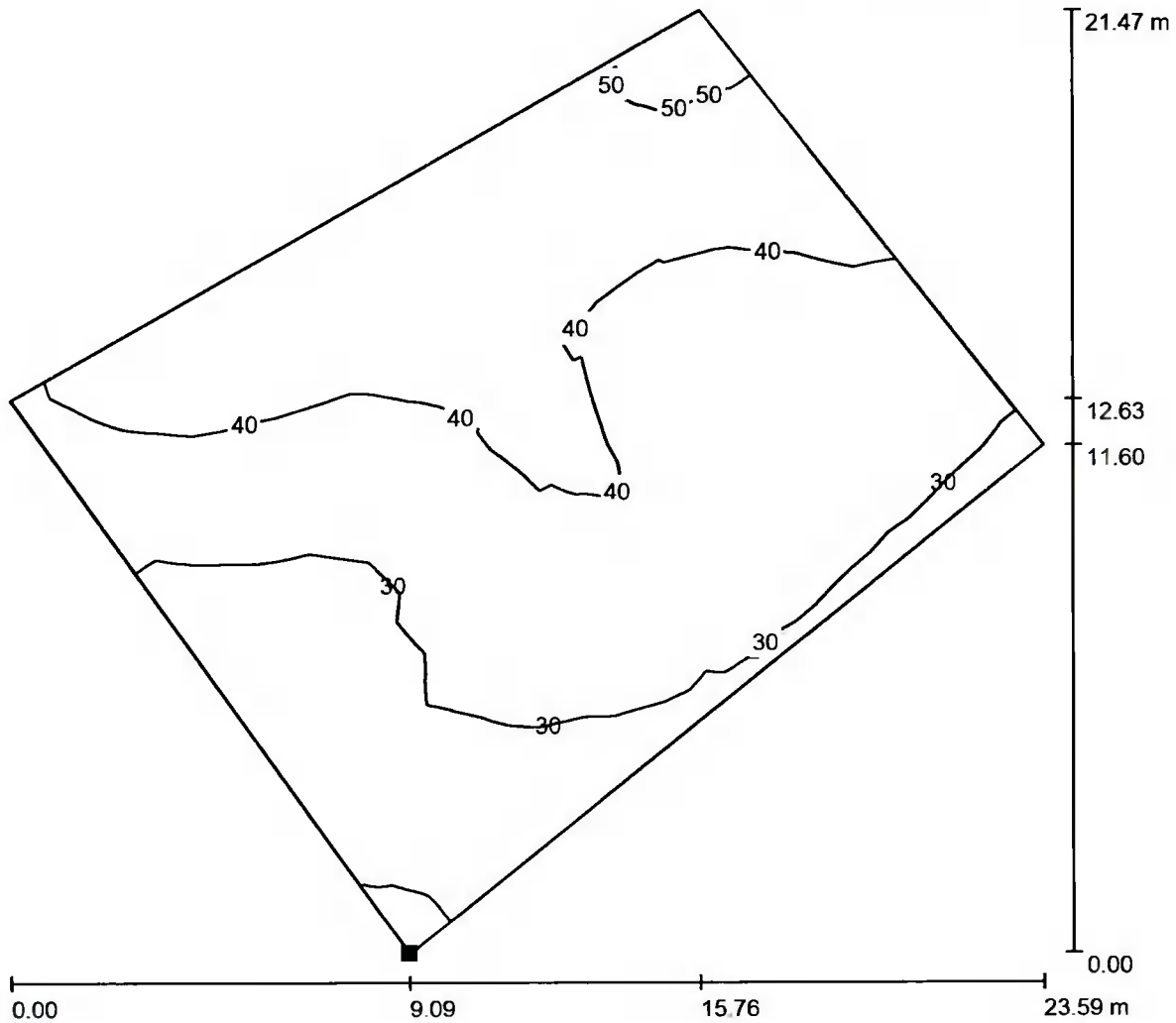

Position of surface in external scene:  
Marked point:  
(239.500 m, 83.700 m, 0.000 m)

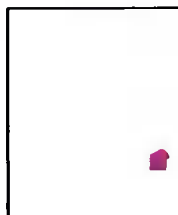

Values in Lux, Scale 1 : 169

Grid: 700 x 700 Points

$E_{av}$  [lx]  
37

$E_{min}$  [lx]  
18

$E_{max}$  [lx]  
51

$u0$   
0.484

$E_{min} / E_{max}$   
0.344



CREATE AMAZING.

Burns & McDonnell Europe (UK) Limited  
Trading as Burns & McDonnell

Cornerblock, 3<sup>rd</sup> Floor  
2 Cornwall Street  
Birmingham, B3 2DL  
Tel: 0121 393 4574

[bmcd.uk@burnsmcd.com](mailto:bmcd.uk@burnsmcd.com) | [www.burnsmcd.com](http://www.burnsmcd.com)