

NOTES:

1. THIS DRAWING IS TO BE READ IN CONJUNCTION WITH ALL RELEVANT KAVANAGH RYAN & ASSOCIATES DRAWINGS AND SPECIFICATIONS.
2. ALL DIMENSIONS TO BE CONFIRMED ON SITE PRIOR TO CONSTRUCTION.

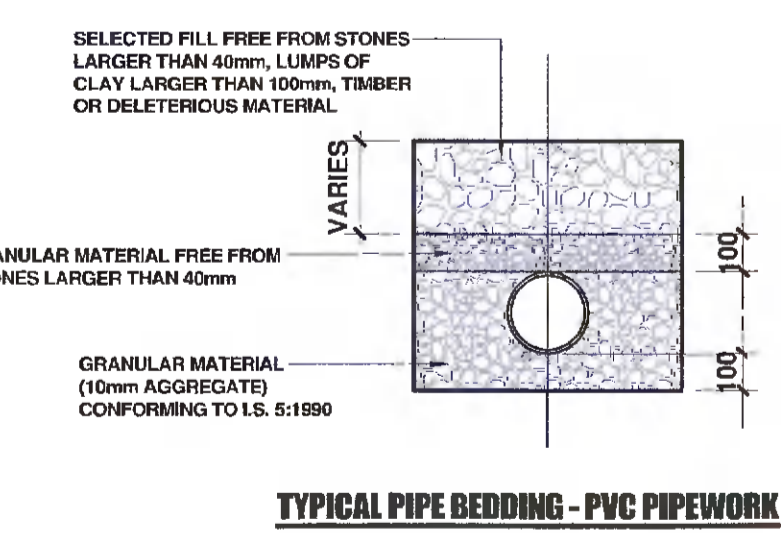
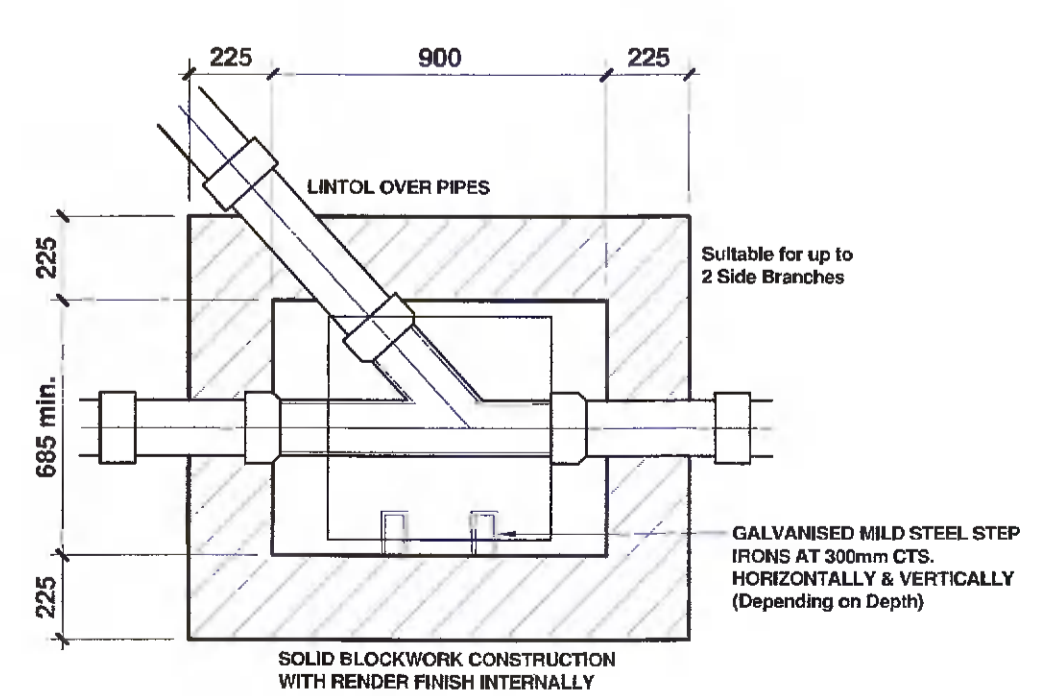
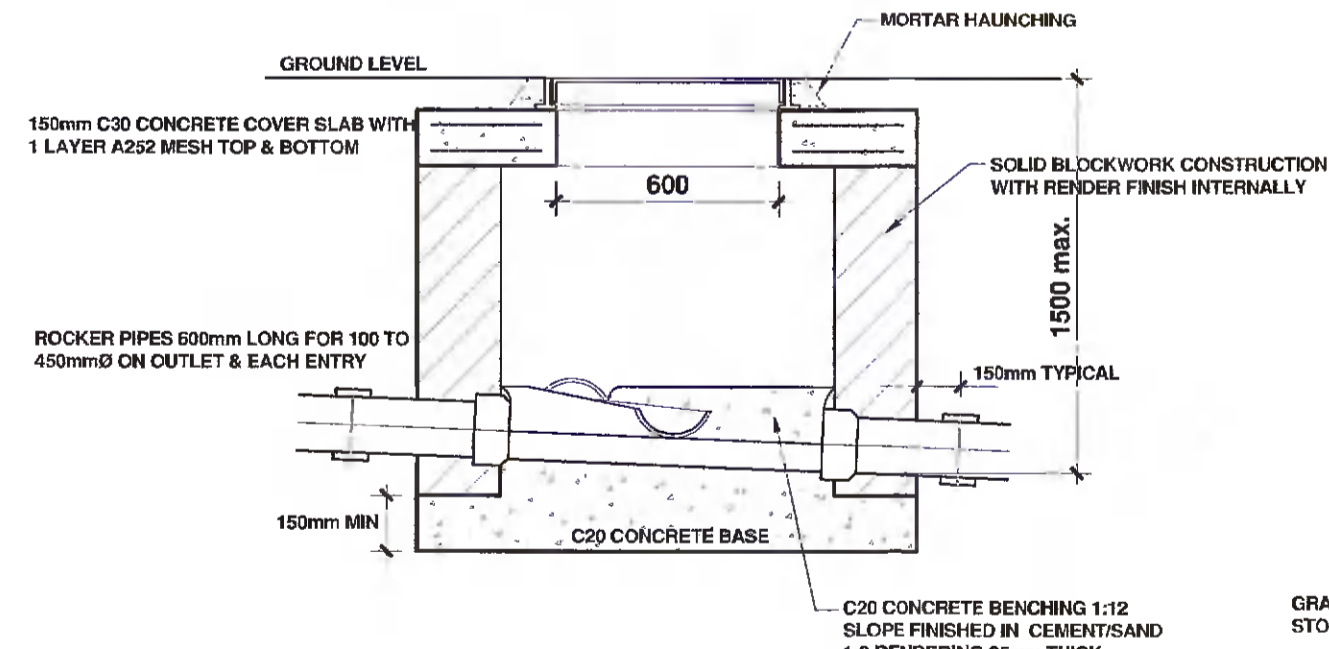
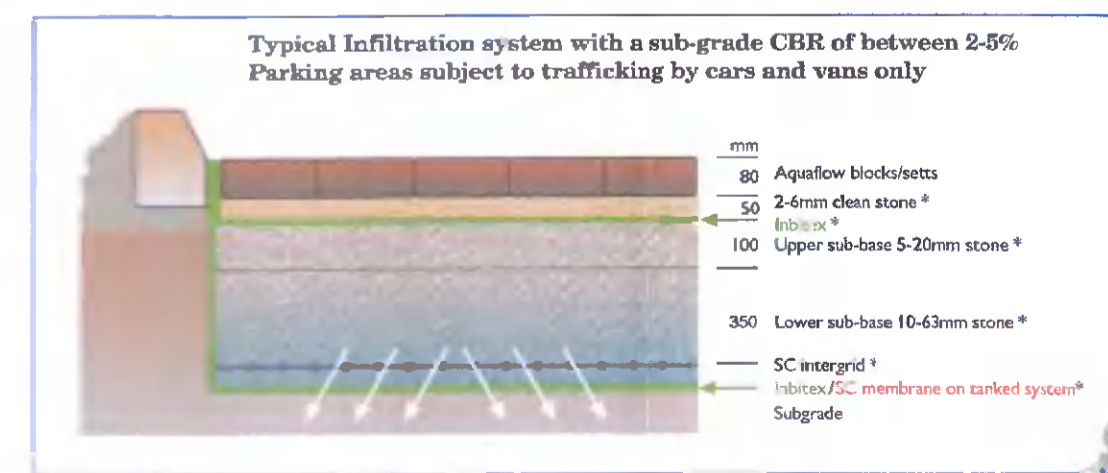
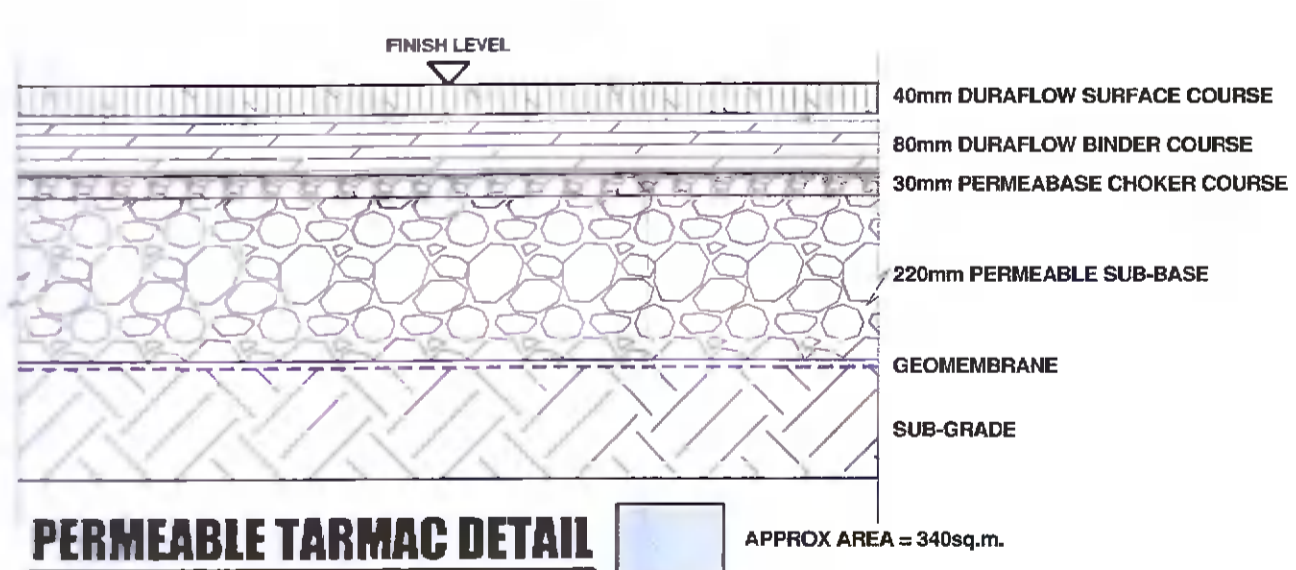
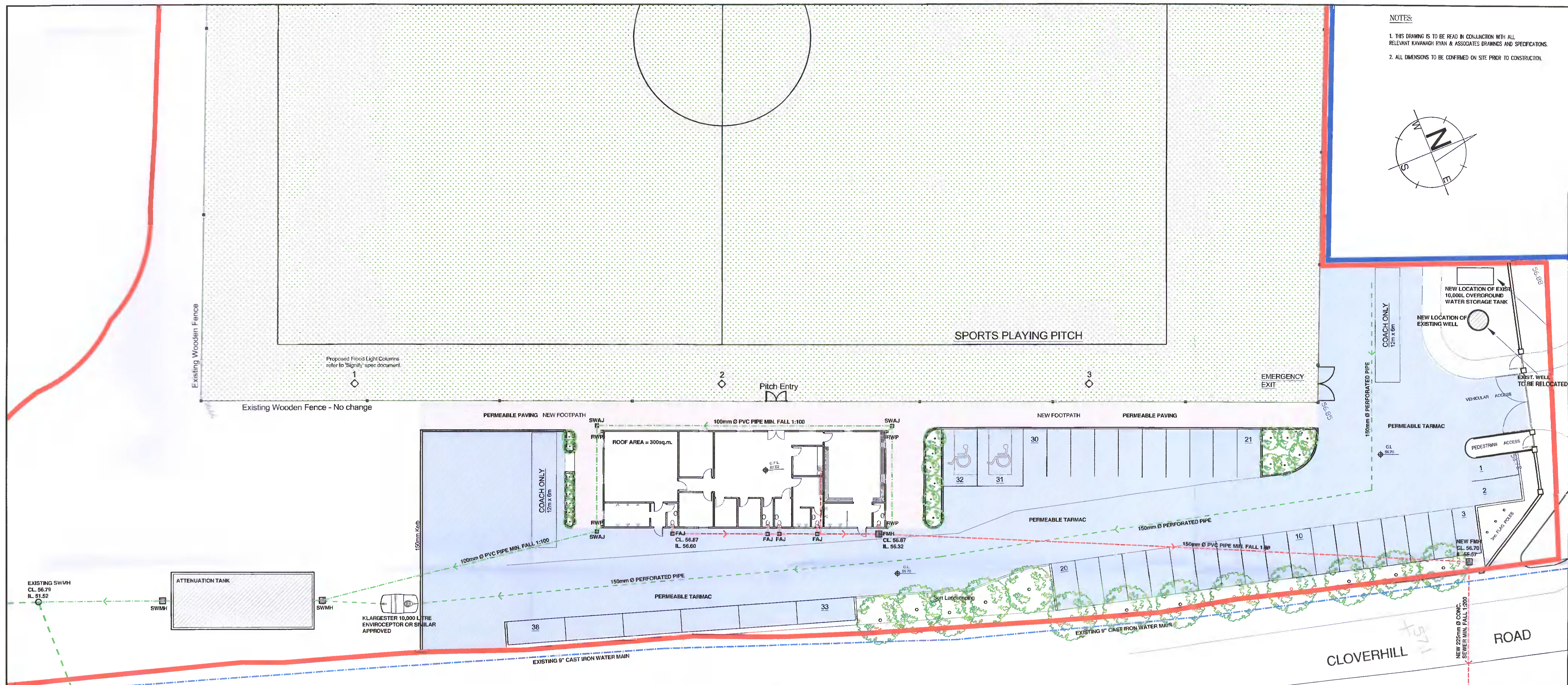
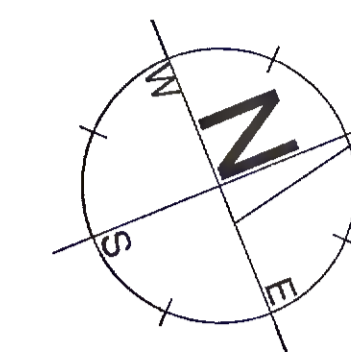

TYPICAL MANHOLE DETAIL
- for Manholes & Pipework less than 1.5m deep

Further Information

no.	revision	date

Kavanagh Ryan & Associates.
 Unit 48, The Egan Centre,
 Dargle Road, Bray,
 Co. Wicklow, A98 WT26
 Tel. 01-2765661
 e: kevin@kavanaghryan.com

PROJECT Ballyfermot United, Cloverhill Road, Clonsilla, Dublin 22.	SCALE 1:200. DATE 12/10/21. DRAWN A.C. JOB NO. C21108.
TITLE Drainage Details.	DRAWING NO. 21108-1.