

**GENERAL NOTES**

- DO NOT SCALE THIS DRAWING. WORK ONLY TO FIGURED DIMENSIONS.
- FOR ALL RELEVANT NOTES, REFER TO STRUCTURAL AND CIVIL ENGINEERING PERFORMANCE SPECIFICATION.
- ANY DISCREPANCIES ARE TO BE REPORTED TO PINNACLE CONSULTING ENGINEERS IMMEDIATELY.
- THIS DRAWING IS TO BE READ IN CONJUNCTION WITH ALL OTHER RELEVANT ENGINEERS, ARCHITECTS AND SUB-CONTRACTORS DRAWINGS AND DETAILS.

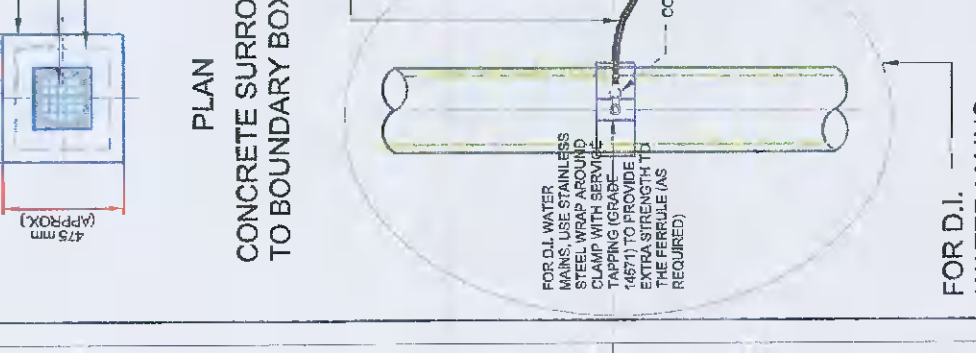
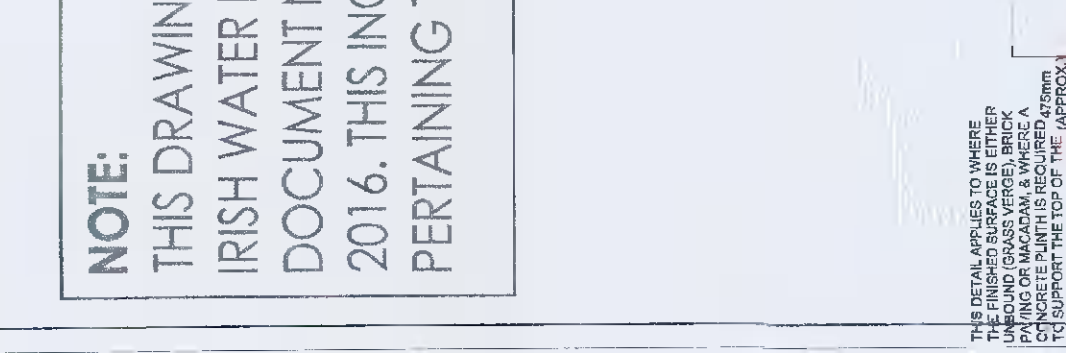
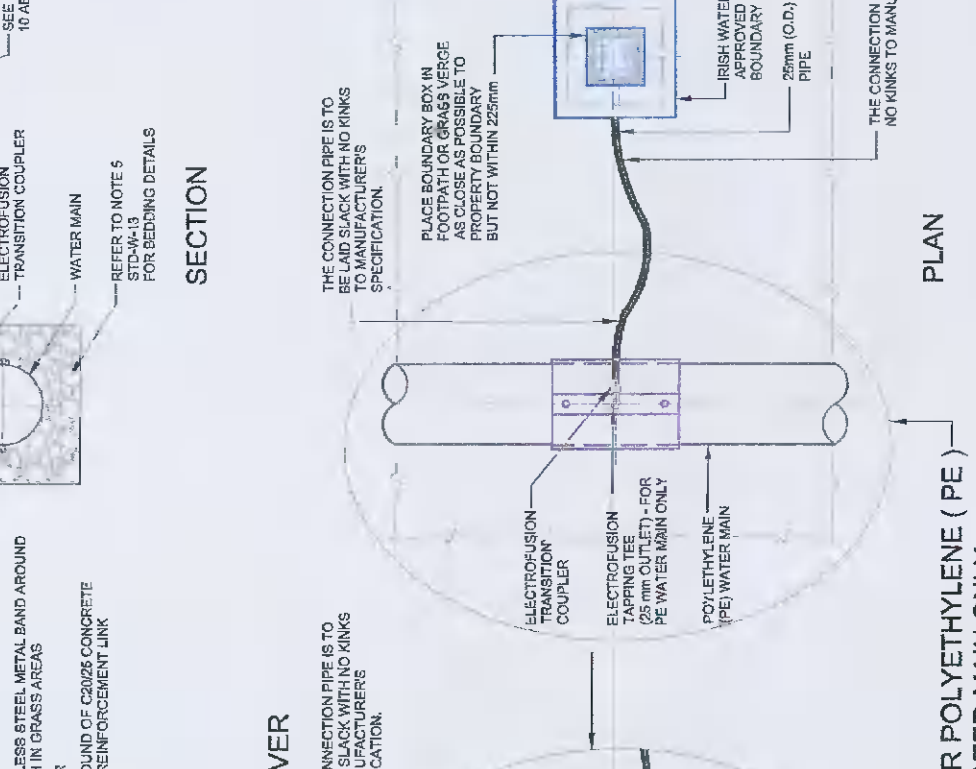
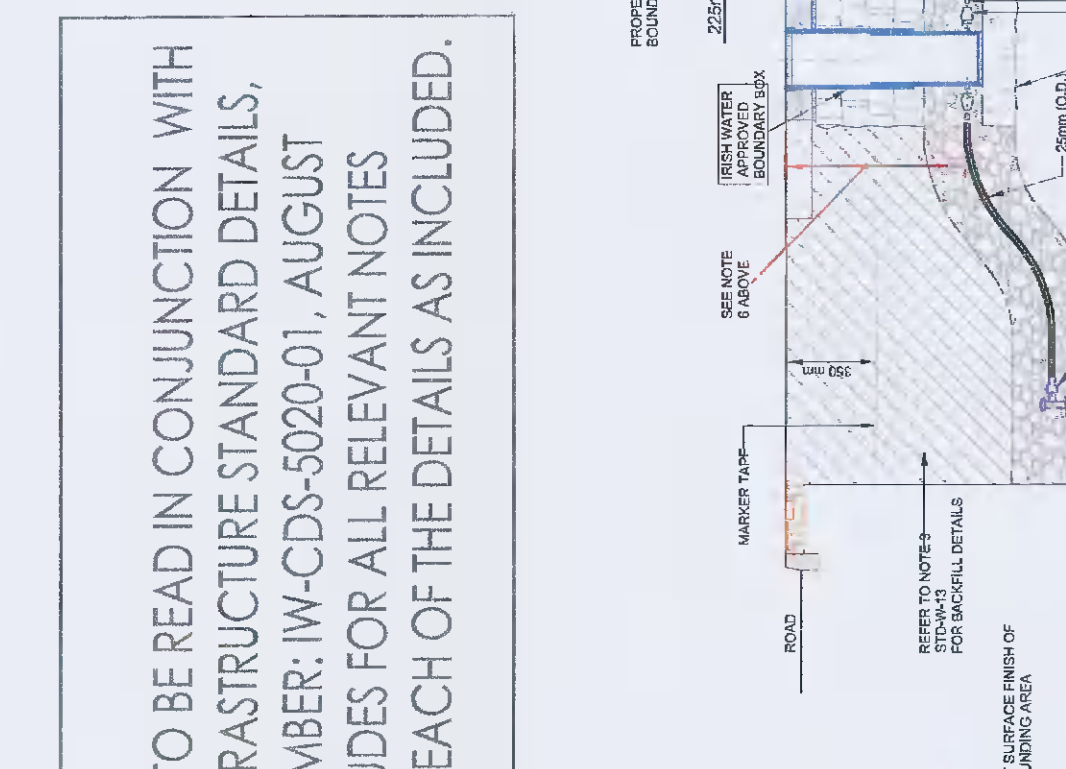
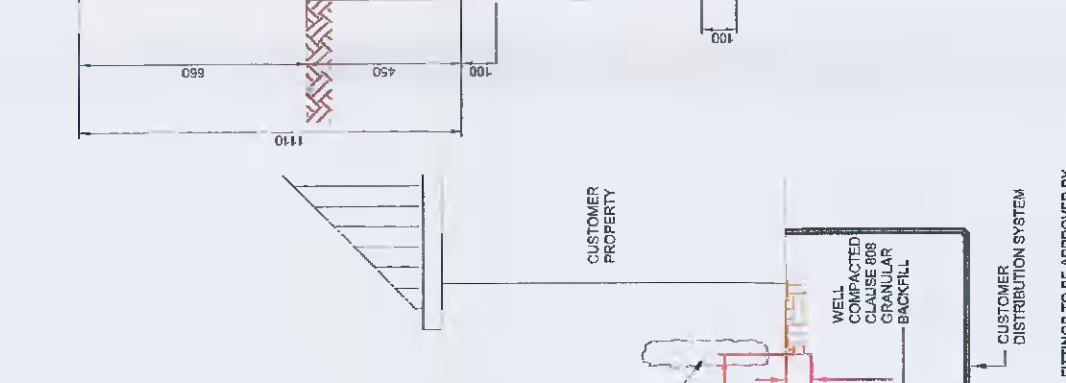
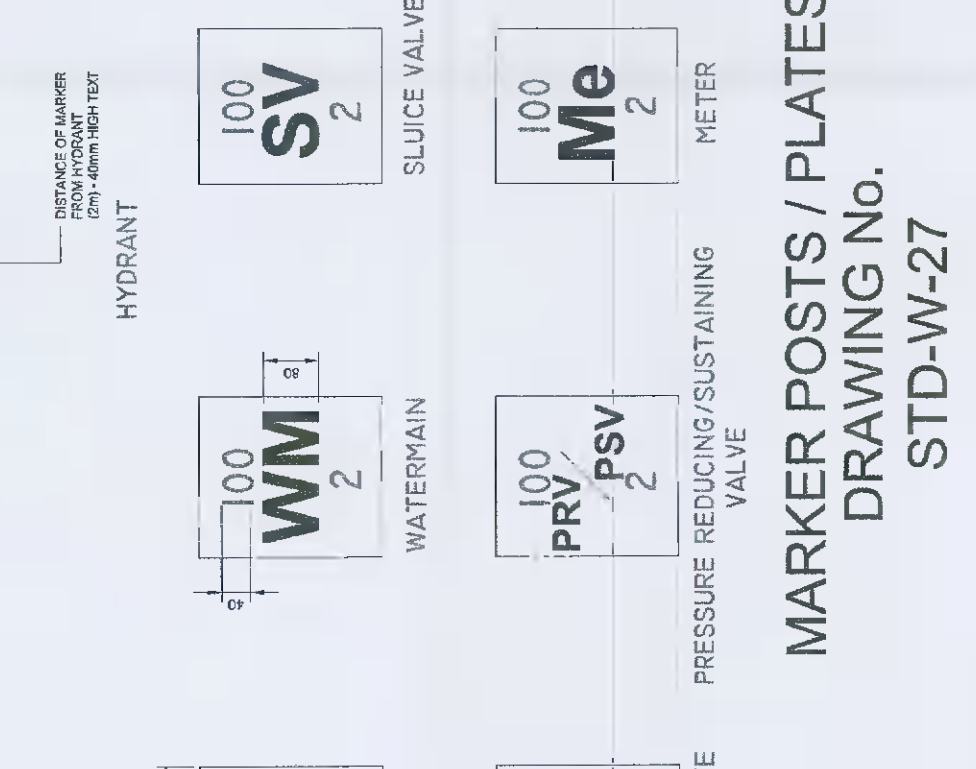
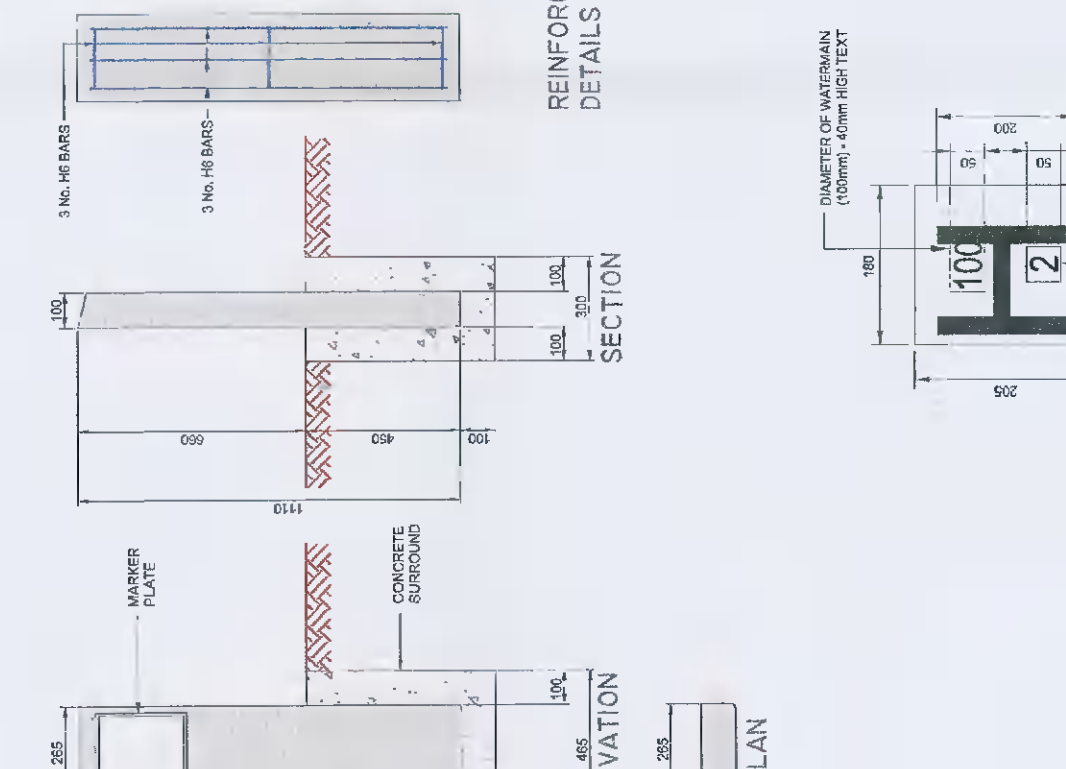
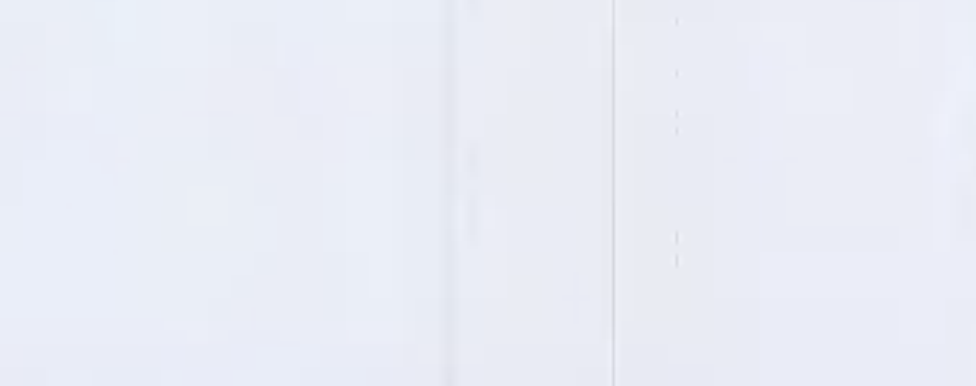
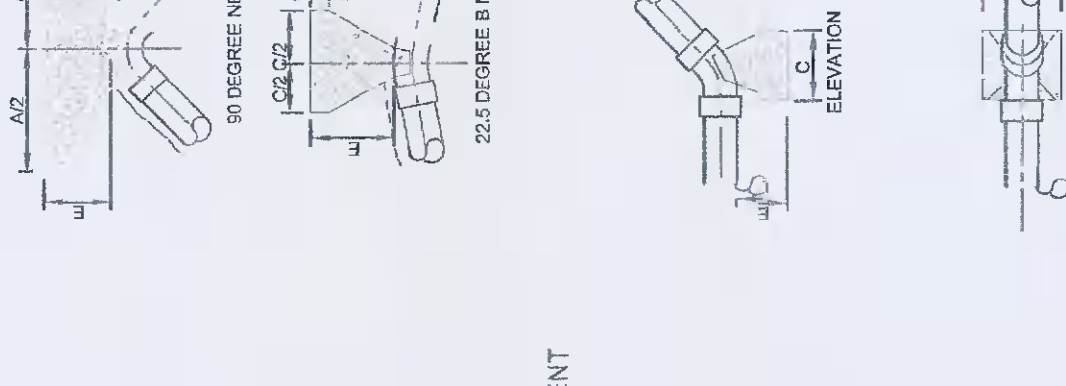
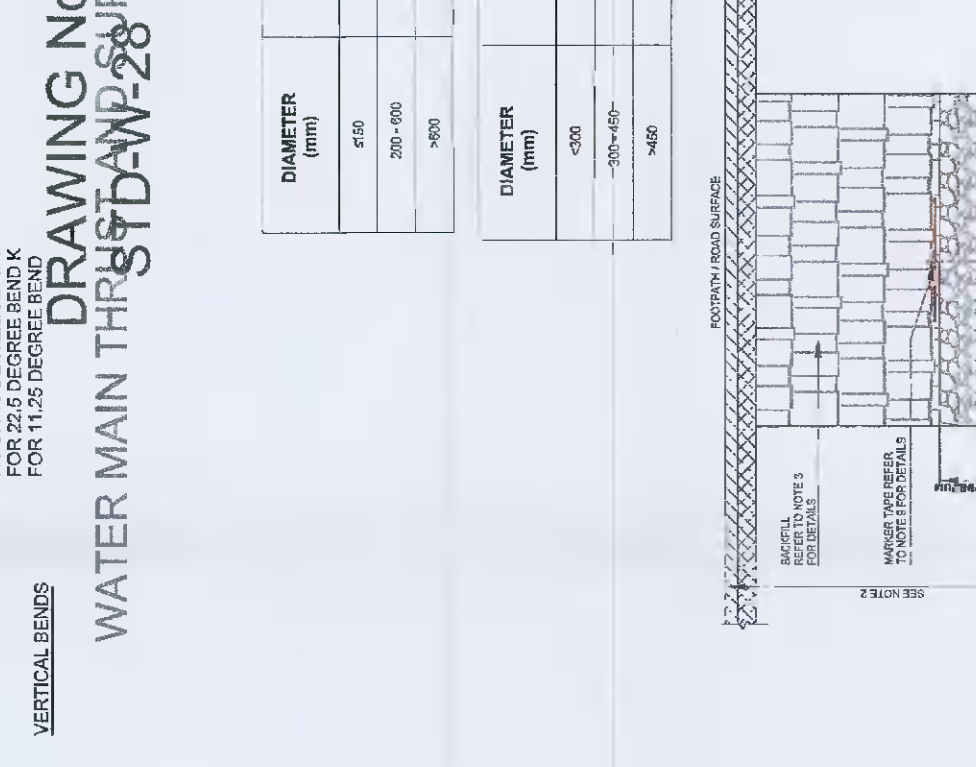
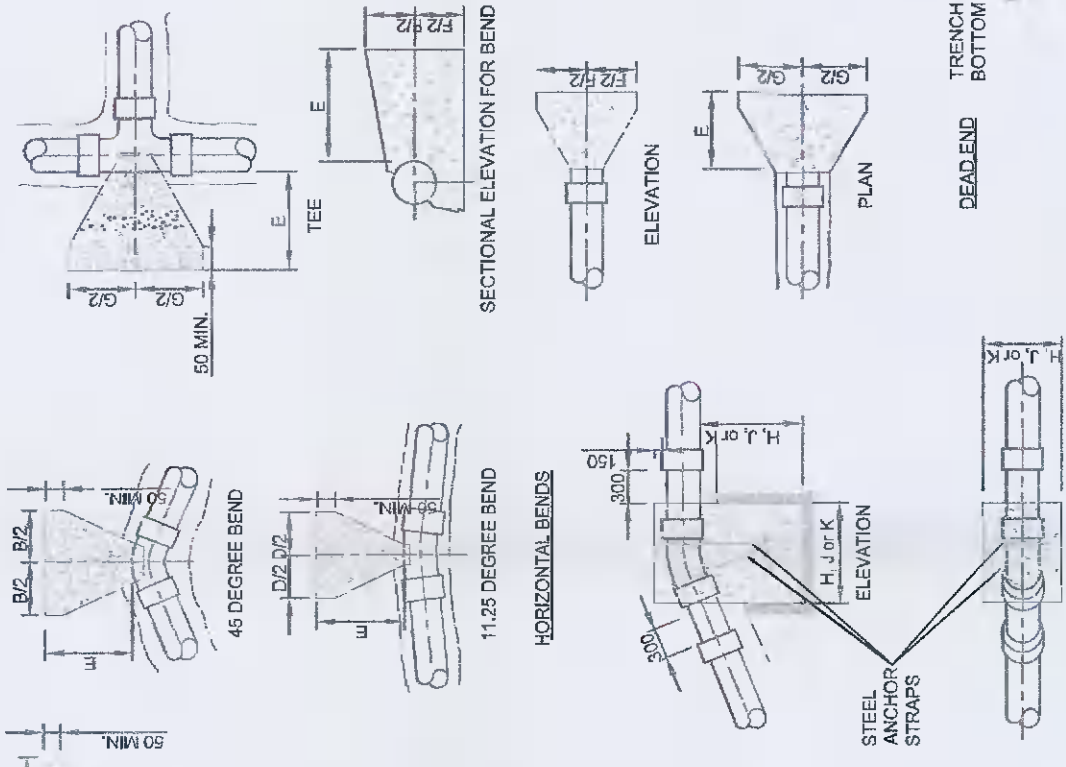
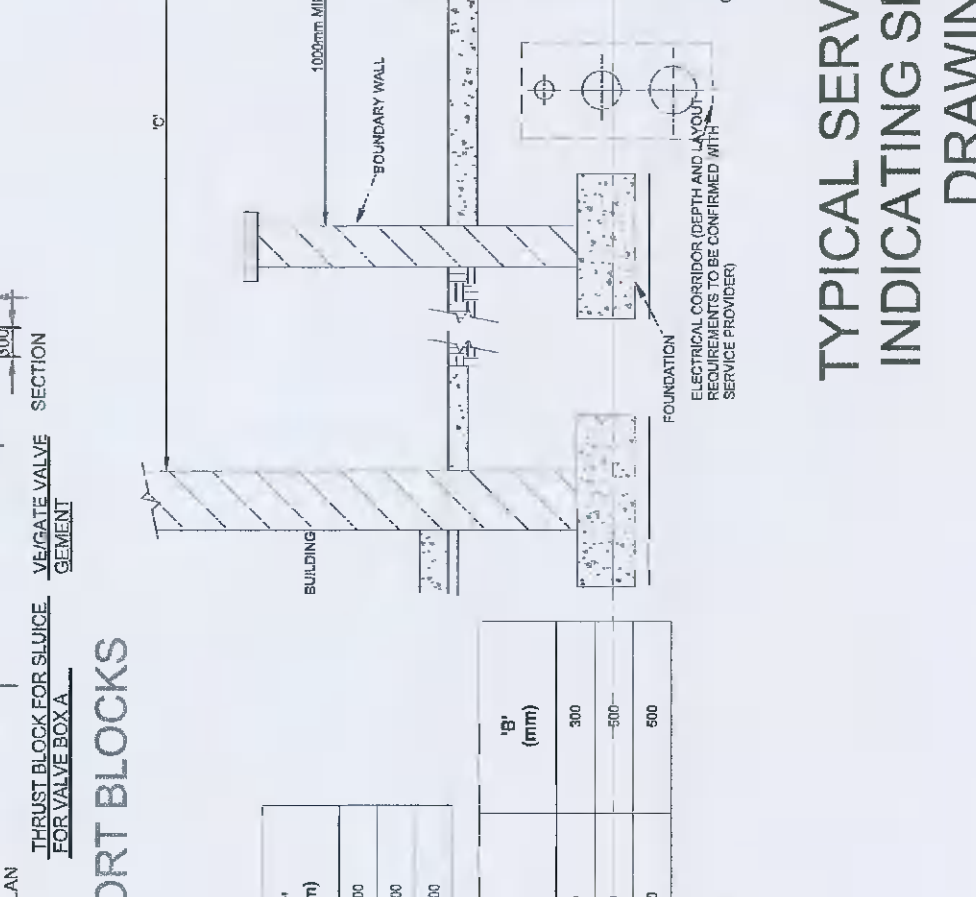
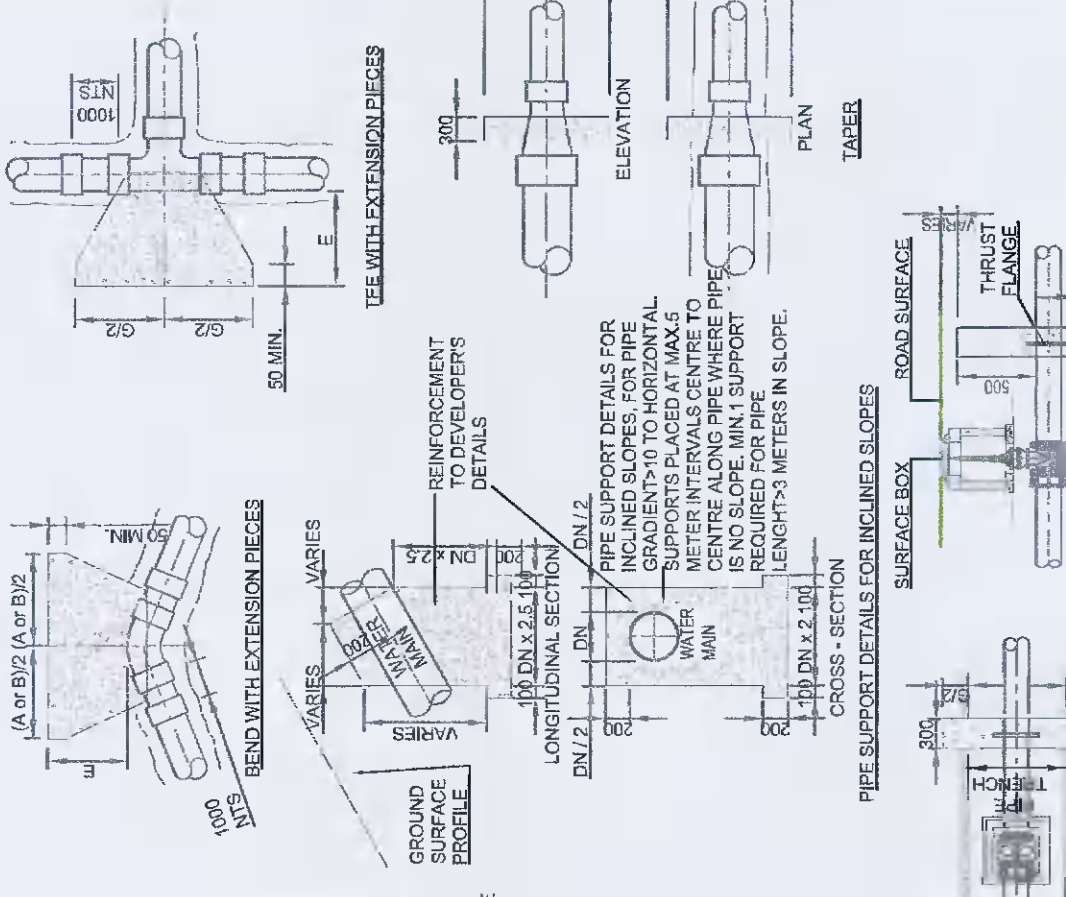
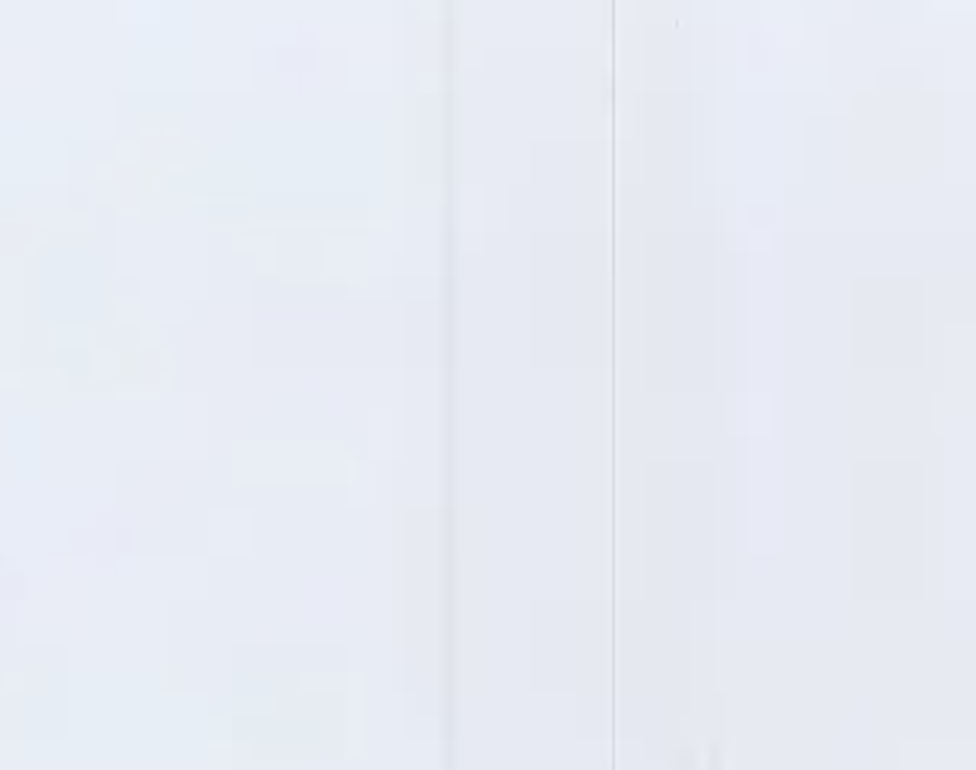
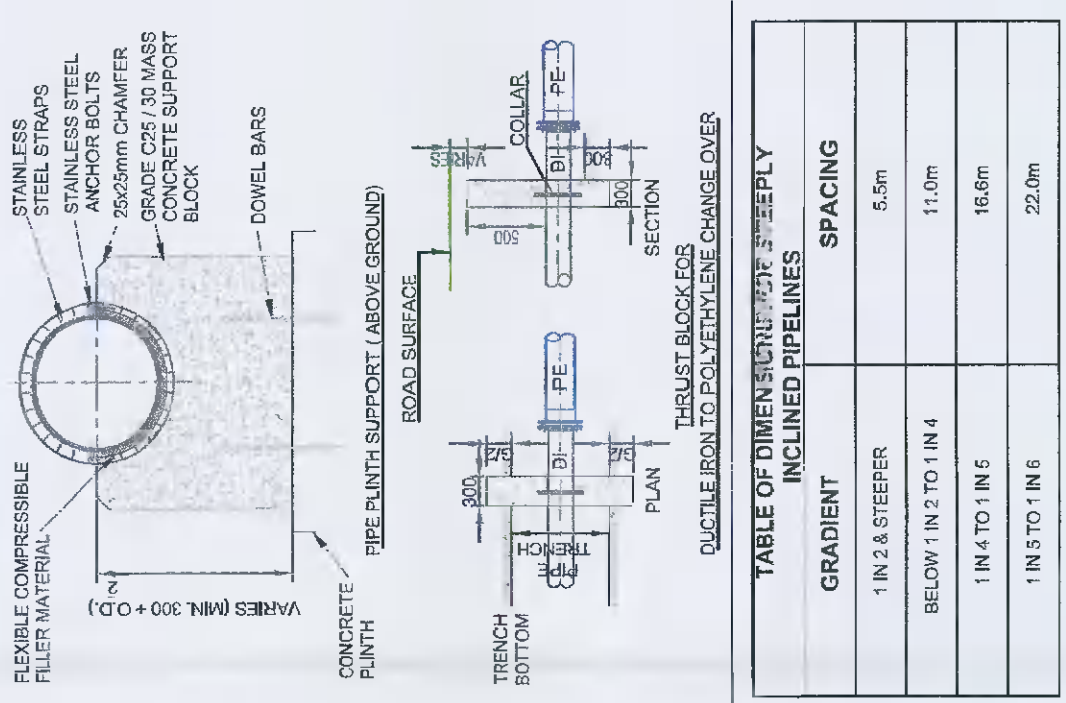

REV	DESCRIPTION	BY	CHK	DATE

CLIENT: EDGECONNEX

PROJECT: EDCDUB05 & GAS PLANT

DRAWING TITLE: STANDARD WATER INFRASTRUCTURE DETAILS

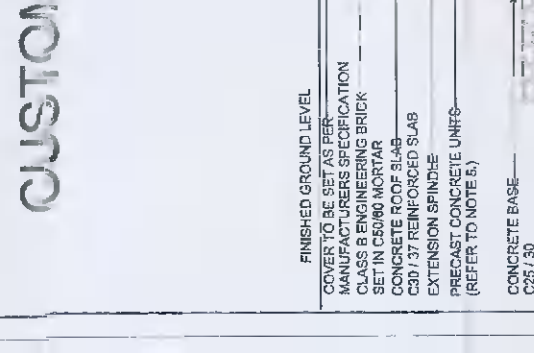
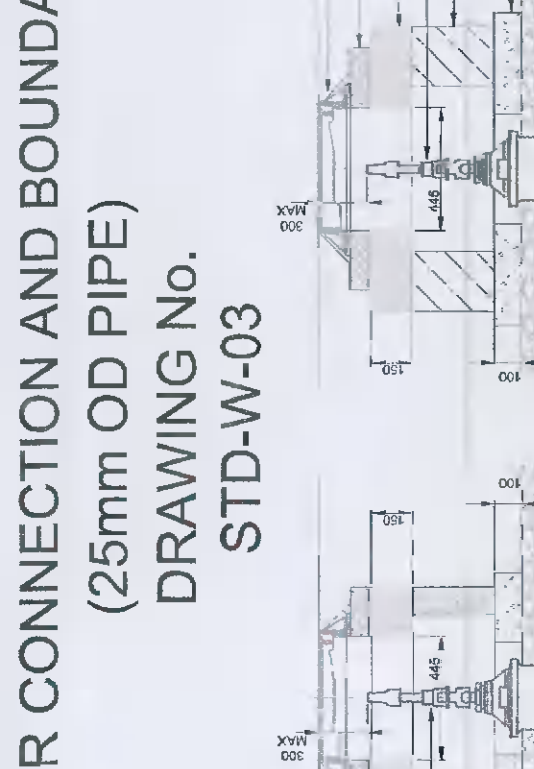
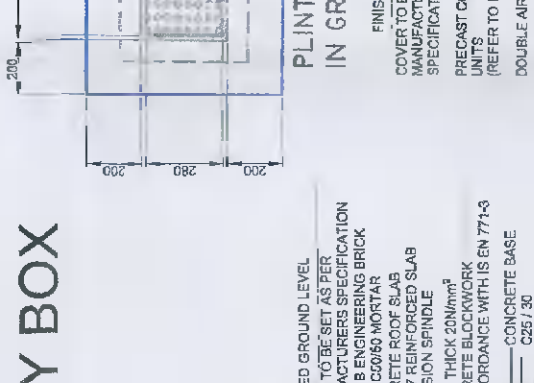
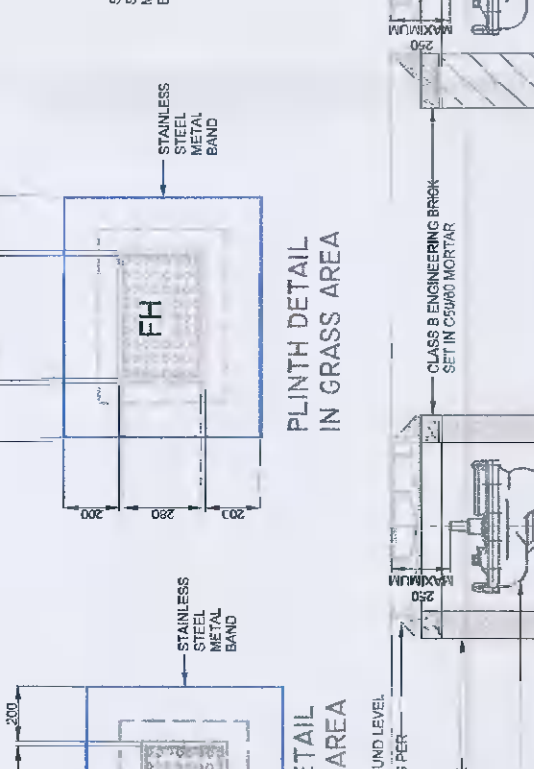
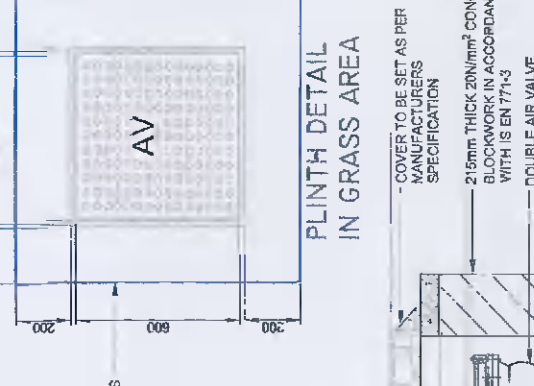
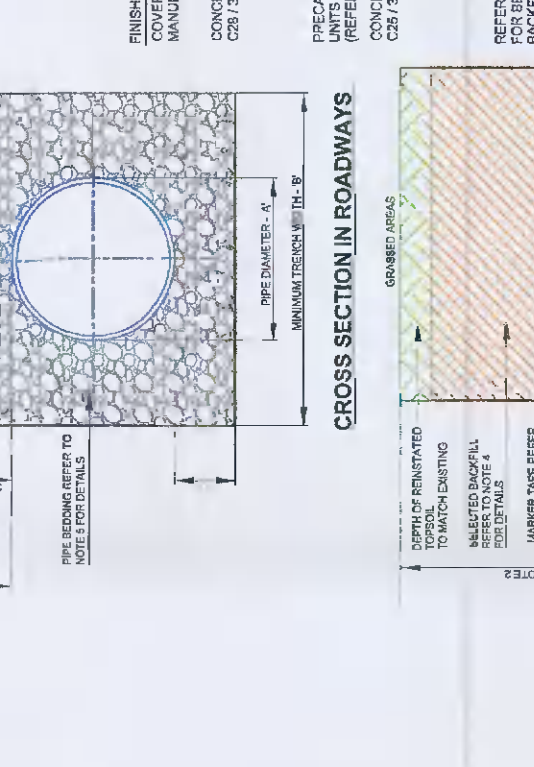
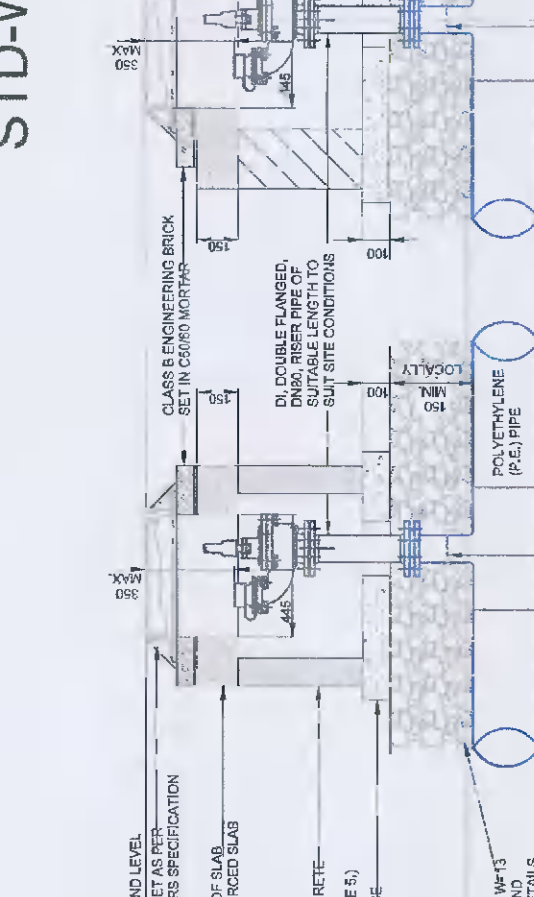

SCALE	DATE	DRWN BY	CHECKED

PROJECT: EDCDUB05 & GAS PLANT

DRAWING TITLE: STANDARD WATER INFRASTRUCTURE DETAILS

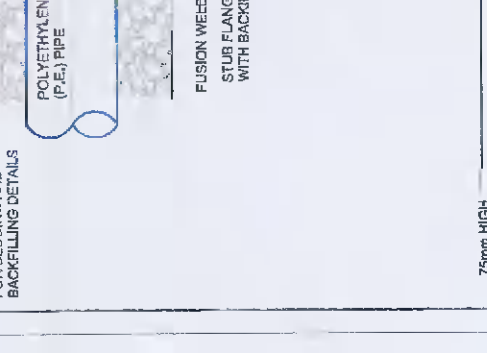
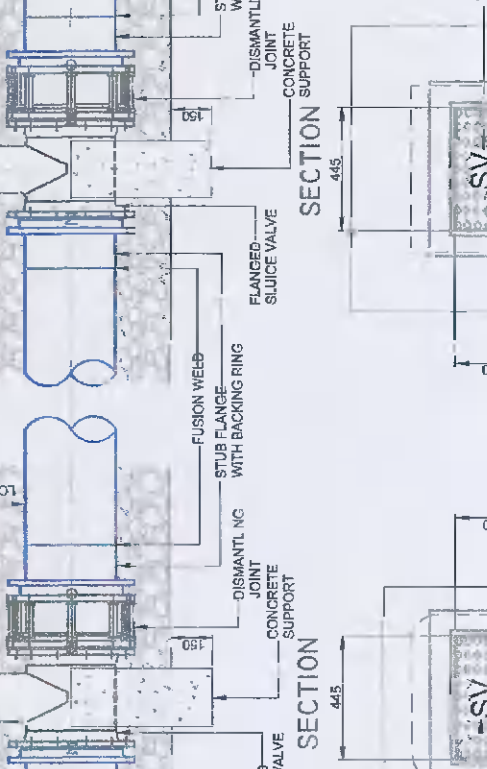
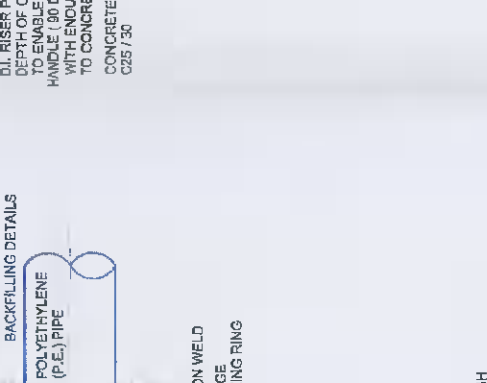
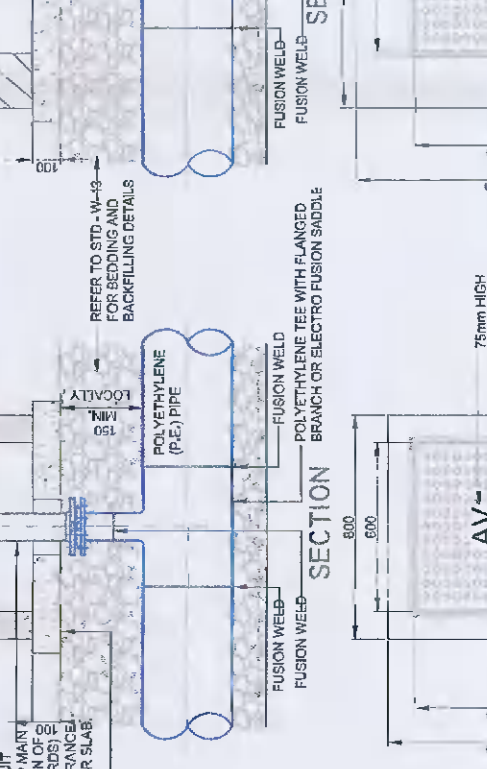
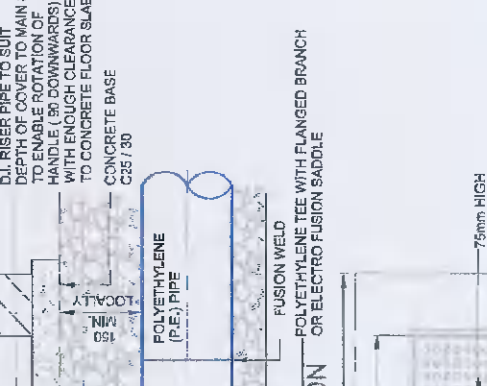
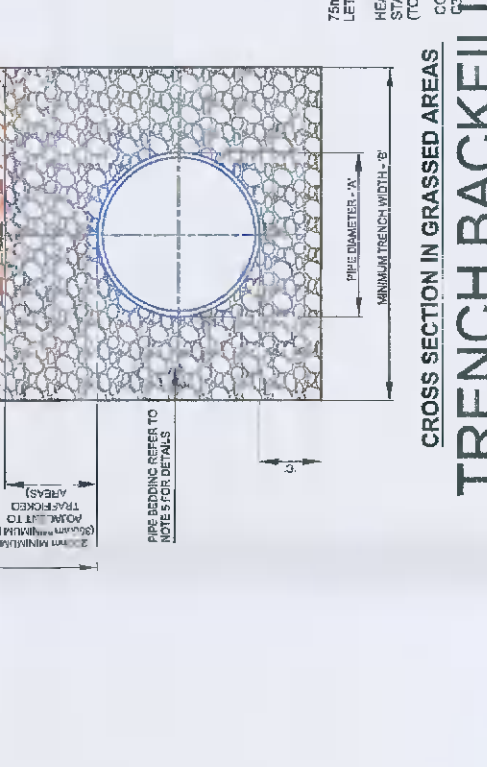
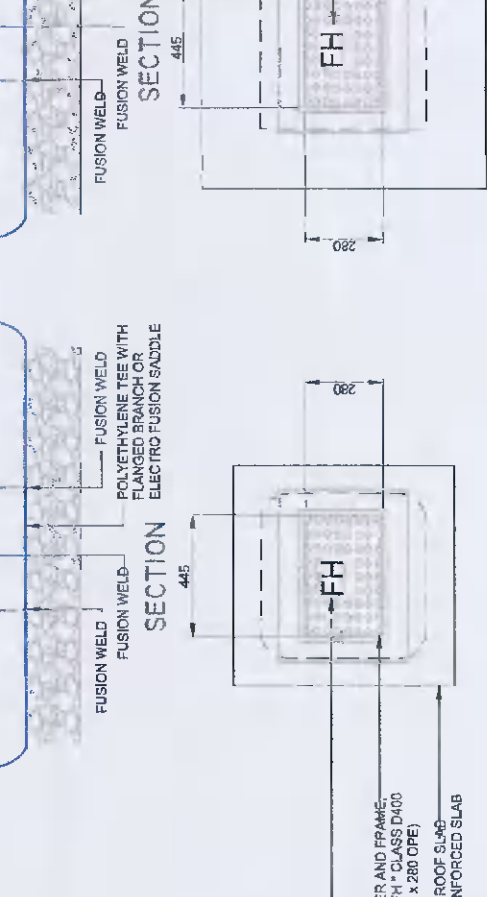

PROJECT: EDCDUB05 & GAS PLANT

DRAWING TITLE: STANDARD WATER INFRASTRUCTURE DETAILS

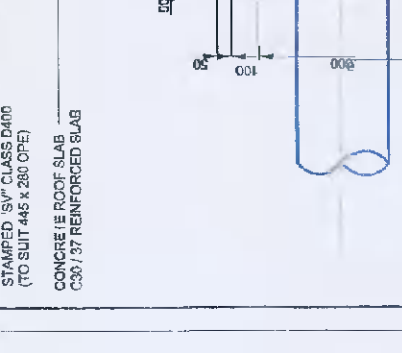
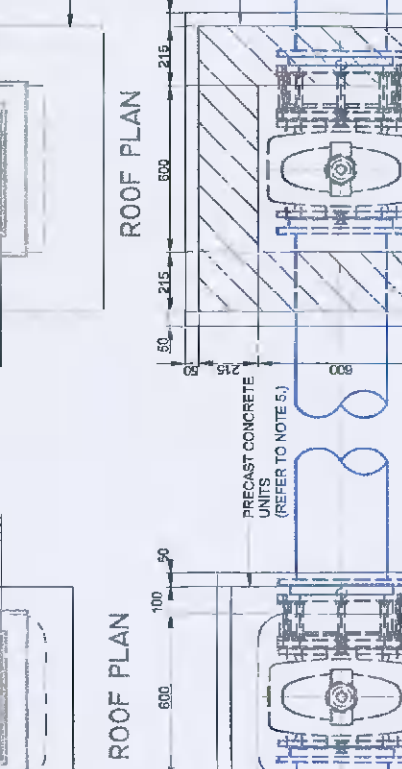
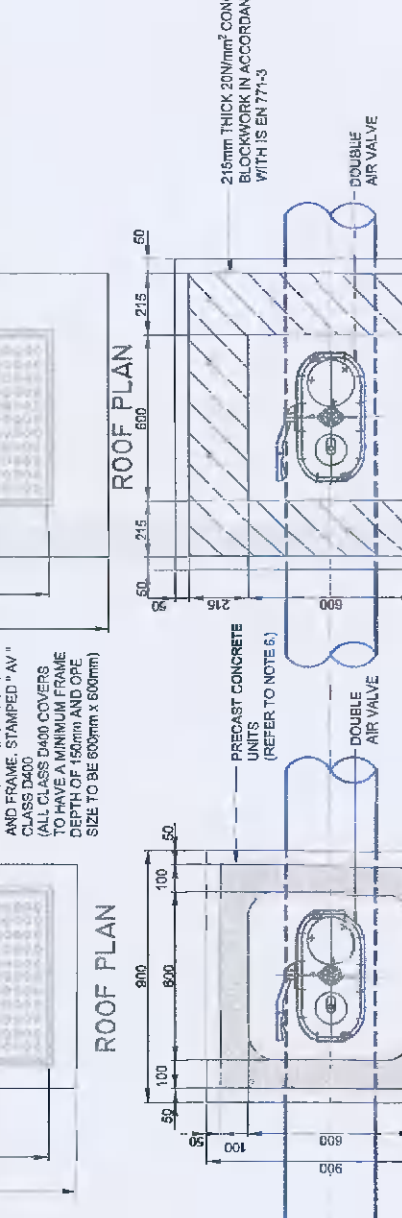
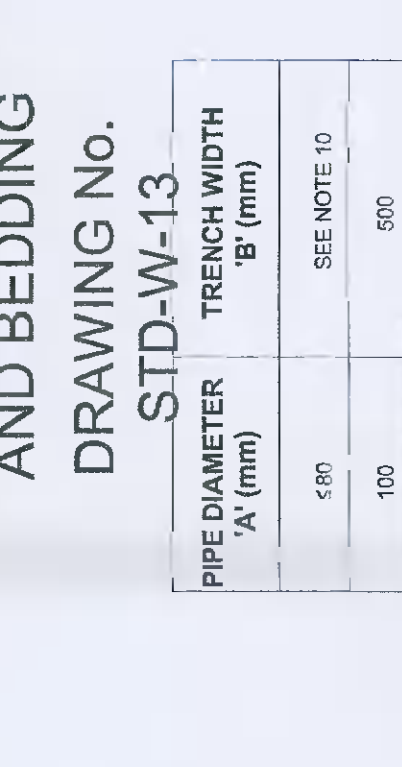
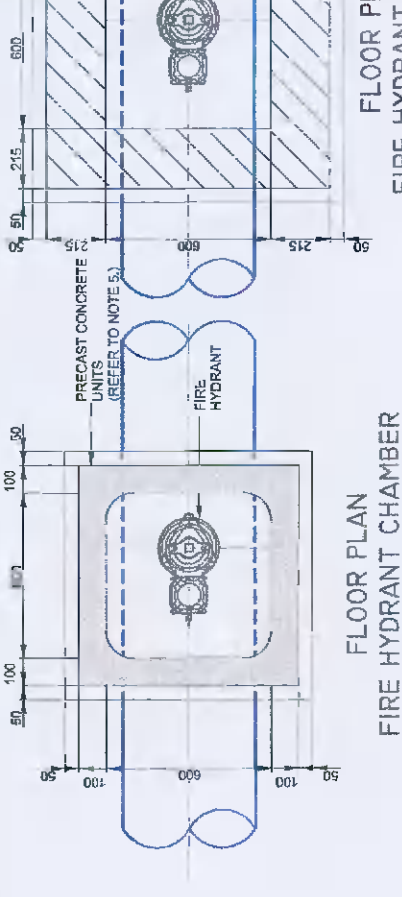

**PINNACLE CONSULTING ENGINEERS**

GROSVENOR COURT,  
87A PATRICK STREET,  
DUBLIN 8,  
IRELAND

TELEPHONE: +353 1 231 1041  
MELWYN GARDEN CITY | NORWICH | LONDON | THE HAGUE

DRAWING STATUS	PLANNING
SCALE	DATE
NTS	DEC '20
DRG NO.	JM
PIN-ZZ-ZZ-DR-DR-0206	JKM
	REVISION
	POI

**PINNACLE CONSULTING ENGINEERS**

GROSVENOR COURT,  
87A PATRICK STREET,  
DUBLIN 8,  
IRELAND

TELEPHONE: +353 1 231 1041  
MELWYN GARDEN CITY | NORWICH | LONDON | THE HAGUE

PIPE DIAMETER 'A' (mm)	TRENCH WIDTH 'B' (mm)	DEPTH OF BEDDING 'C' (mm)
< 80	SEE NOTE 10	200
100	500	200
150	600	200
200	600	200
250	750	200
300	750	200
350	750	200
400	900	200
450	900	200
< 200	150	200
> 250	200	200

**PINNACLE CONSULTING ENGINEERS**

GROSVENOR COURT,  
87A PATRICK STREET,  
DUBLIN 8,  
IRELAND

TELEPHONE: +353 1 231 1041  
MELWYN GARDEN CITY | NORWICH | LONDON | THE HAGUE

PIPE DIAMETER 'A' (mm)	TRENCH WIDTH 'B' (mm)	DEPTH OF BEDDING 'C' (mm)
< 80	SEE NOTE 10	200
100	500	200
150	600	200
200	600	200
250	750	200
300	750	200
350	750	200
400	900	200
450	900	200
< 200	150	200
> 250	200	200

**PINNACLE CONSULTING ENGINEERS**

GROSVENOR COURT,  
87A PATRICK STREET,  
DUBLIN 8,  
IRELAND

TELEPHONE: +353 1 231 1041  
MELWYN GARDEN CITY | NORWICH | LONDON | THE HAGUE

PIPE DIAMETER 'A' (mm)	TRENCH WIDTH 'B' (mm)	DEPTH OF BEDDING 'C' (mm)
< 80	SEE NOTE 10	200
100	500	200
150	600	200
200	600	200
250	750	200
300	750	200
350	750	200
400	900	200
450	900	200
< 200	150	200
> 250	200	200